



## CMB型 卧式多级离心泵

HORIZONTAL MULTI-STAGE CENTRIFUGAL PUMP



**Main office:**

Add: Building A, No. 4288 Hutai Road, Baoshan District, Shanghai, China

E-mail: [infor@aikonchina.com](mailto:infor@aikonchina.com)

Website: [www.aikonchina.com](http://www.aikonchina.com)

[www.aikoncontrol.com](http://www.aikoncontrol.com)

**Moscow office:**

Add: Moscow, Volokolamsk highway, 73, office 210

Tel: +7-499-703-35-23 +7-800-333-10-74

E-mail: [aikon@aikonrussia.ru](mailto:aikon@aikonrussia.ru)

Website: [www.aikonrussia.ru](http://www.aikonrussia.ru)

**SHANGHAI PUMPING TECH INTERNATIONAL CO., LTD**



SHANGHAI PUMPING TECH INTERNATIONAL CO., LTD

### 结构剖面图

- 1、吸入段
- 2、导叶
- 3、中段
- 4、吐出段
- 5、首级叶轮
- 6、叶轮
- 7、平衡盘
- 8、平衡环
- 9、尾盖
- 10、填料
- 11、平衡套
- 12、填料压盖
- 13、O形圈
- 14、轴承
- 15、首级密封环
- 16、密封环
- 17、导叶套
- 18、轴
- 19、轴套
- 20、平衡水管部件
- 21、水封管部件

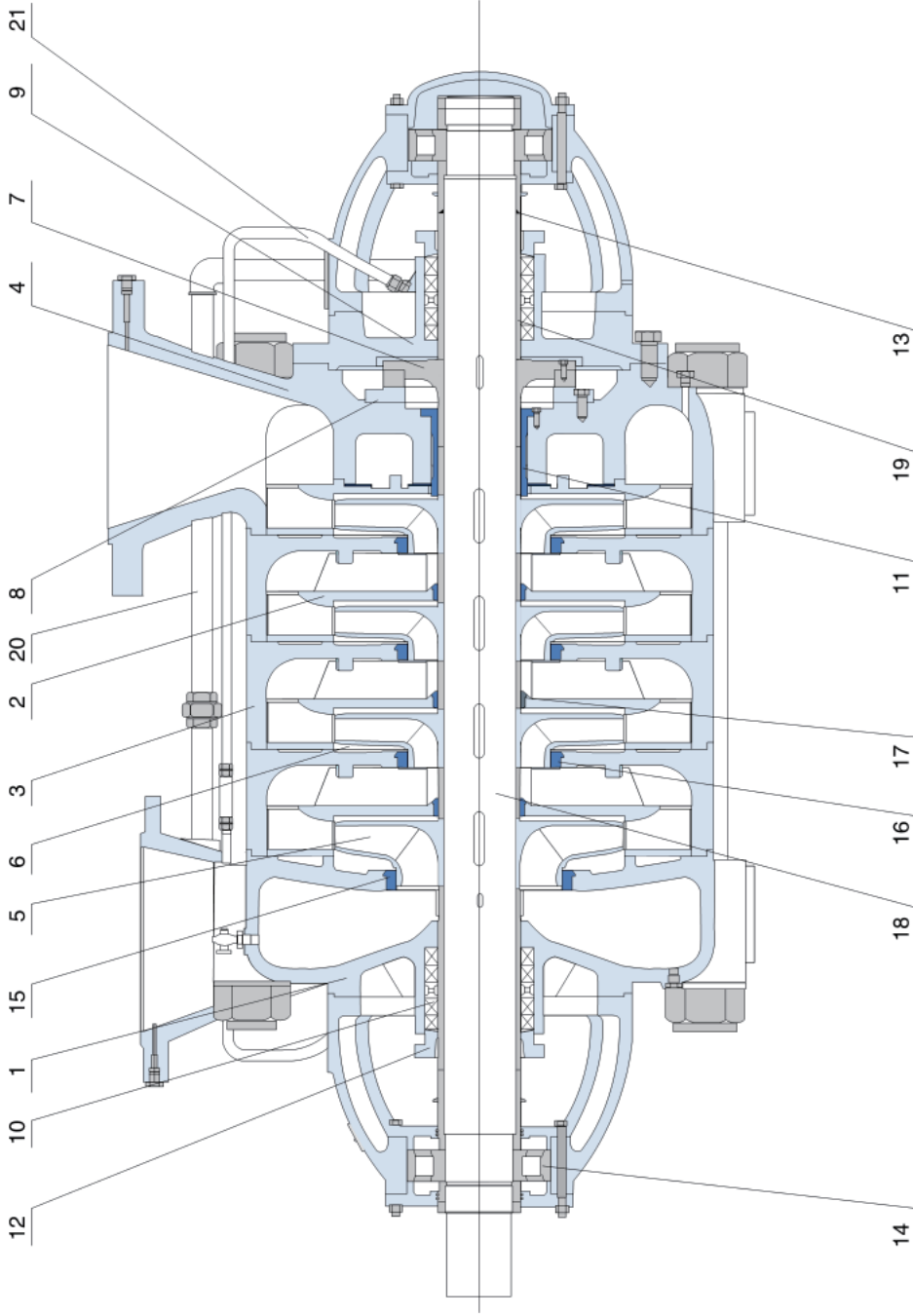

### Structural Arrangement

1. Suction Casing
2. Diffuser
3. Stage Casing
4. Delivery Casing
5. Impeller Of First-stage
6. Impeller
7. Balance Disc
8. Balance Ring
9. Stuffing Box Housing
10. Packing
11. Balance Sleeve
12. Packing Gland
13. O-ring
14. Bearing
15. Wearing Ring Of First-stage
16. Wearing Ring
17. Diffuser Bush
18. Shaft
19. Shaft Sleeve
20. Balance Water Piping
21. Water Seal Piping

CMB 性能曲线

CMB Performance Curve

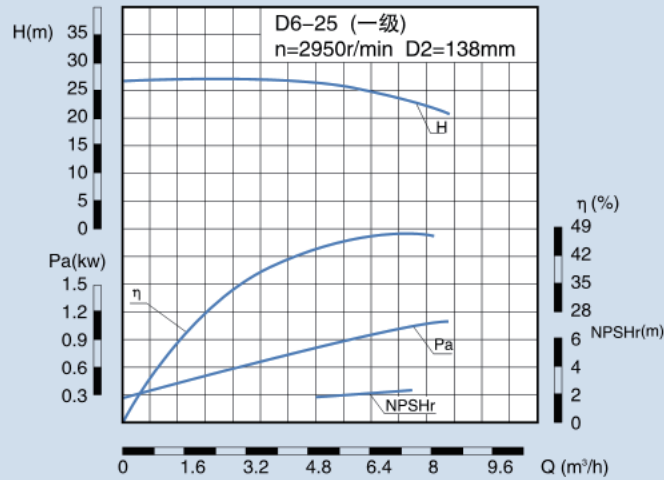

CMB 性能表

CMB Performance Data

级数 Series	流量 Capacity Q		扬程 Head H	转速 Speed n	轴功率 Shaft power Pa	配带电动机 Motor		效率 Eff. η	必需汽 蚀余量 (NPSH)r	叶轮名 义直径 Impeller Dia.	泵重 Weight
	m³/h	L/S	m	r/min	kW	功率 Power	型号 Type	%	m	mm	kg
						kW					
2	3.75	1.04	51	2950	1.49	3	Y100L-2	35	2.0	φ 138	80
	6.3	1.75	50		1.84			46.5	2.0		
	7.5	2.08	49		2.08			48	2.5		
3	3.75	1.04	76.5	2950	2.23	5.5	Y132S <sub>1</sub> -2	35	2.0	φ 138	90
	6.3	1.75	75		2.77			46.5	2.0		
	7.5	2.08	73.5		3.12			48	2.5		
4	3.75	1.04	102	2950	2.98	7.5	Y132S <sub>2</sub> -2	35	2.0	φ 138	100
	6.3	1.75	100		3.69			46.5	2.0		
	7.5	2.08	98		4.16			48	2.5		
5	3.75	1.04	127.5	2950	3.73	7.5	Y132S <sub>2</sub> -2	35	2.0	φ 138	110
	6.3	1.75	125		4.61			46.5	2.0		
	7.5	2.08	122.5		5.20			48	2.5		
6	3.75	1.04	153	2950	4.47	11	Y160M <sub>1</sub> -2	35	2.0	φ 138	120
	6.3	1.75	150		5.53			46.5	2.0		
	7.5	2.08	147		6.24			48	2.5		
7	3.75	1.04	178.5	2950	5.22	11	Y160M <sub>1</sub> -2	35	2.0	φ 138	130
	6.3	1.75	175		6.45			46.5	2.0		
	7.5	2.08	171.5		7.28			48	2.5		
8	3.75	1.04	204	2950	5.96	15	Y160M <sub>2</sub> -2	35	2.0	φ 138	140
	6.3	1.75	200		7.37			46.5	2.0		
	7.5	2.08	196		8.32			48	2.5		
9	3.75	1.04	229.5	2950	6.71	15	Y160M <sub>2</sub> -2	35	2.0	φ 138	150
	6.3	1.75	225		8.29			46.5	2.0		
	7.5	2.08	220.5		9.36			48	2.5		
10	3.75	1.04	255	2950	7.45	18.5	Y160L-2	35	2.0	φ 138	160
	6.3	1.75	250		9.21			46.5	2.0		
	7.5	2.08	245		10.40			48	2.5		
11	3.75	1.04	280.5	2950	8.20	18.5	Y160L-2	35	2.0	φ 138	170
	6.3	1.75	275		10.13			46.5	2.0		
	7.5	2.08	269.5		11.44			48	2.5		
12	3.75	1.04	306	2950	8.94	18.5	Y160L-2	35	2.0	φ 138	180
	6.3	1.75	300		11.05			46.5	2.0		
	7.5	2.08	294		12.48			48	2.5		

### CMB 6-50 性能曲线

### CMB 6-50 Performance Curve

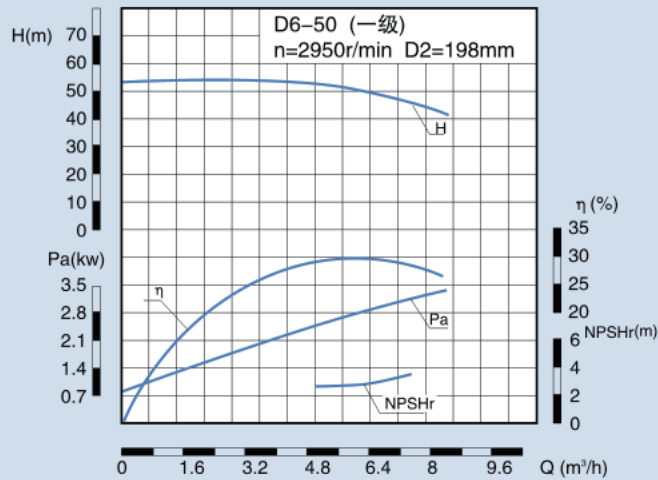

### CMB 6-50 性能表

### CMB 6-50 Performance Data

级数 Series	流量 Capacity Q		扬程 Head H	转速 Speed n	轴功率 Shaft power Pa	配带电动机 Motor		效率 Eff. η	必需汽 蚀余量 (NPSH)r	叶轮名 义直径 Impeller Dia.	泵重 Weight
	m³/h	L/S				功率 Power	型号 Type				
					%			m	mm	kg	
2	3.75	1.04	104	2950	3.79	11	Y160M <sub>1</sub> -2	28	3.0	φ 198	140
	6.3	1.75	100		5.72			30	3.0		
	7.5	2.08	96		6.76			29	3.5		
3	3.75	1.04	106	2950	5.69	15	Y160M <sub>2</sub> -2	28	3.0	φ 198	160
	6.3	1.75	150		8.58			30	3.0		
	7.5	2.08	144		10.1			29	3.5		
4	3.75	1.04	208	2950	7.58	18.5	Y160L-2	28	3.0	φ 198	180
	6.3	1.75	200		11.4			30	3.0		
	7.5	2.08	192		13.5			29	3.5		
5	3.75	1.04	260	2950	9.48	22	Y180M-2	28	3.0	φ 198	200
	6.3	1.75	250		14.3			30	3.0		
	7.5	2.08	240		16.9			29	3.5		
6	3.75	1.04	312	2950	11.4	30	Y200L <sub>1</sub> -2	28	3.0	φ 198	220
	6.3	1.75	300		17.2			30	3.0		
	7.5	2.08	288		20.3			29	3.5		
7	3.75	1.04	364	2950	13.3	30	Y200L <sub>1</sub> -2	28	3.0	φ 198	240
	6.3	1.75	350		20.0			30	3.0		
	7.5	2.08	336		23.7			29	3.5		
8	3.75	1.04	416	2950	15.2	37	Y200L <sub>2</sub> -2	28	3.0	φ 198	260
	6.3	1.75	400		22.9			30	3.0		
	7.5	2.08	384		27.0			29	3.5		
9	3.75	1.04	468	2950	17.1	37	Y200L <sub>2</sub> -2	28	3.0	φ 198	280
	6.3	1.75	450		25.7			30	3.0		
	7.5	2.08	432		30.4			29	3.5		
10	3.75	1.04	520	2950	19.0	45	Y225M-2	28	3.0	φ 198	300
	6.3	1.75	500		28.6			30	3.0		
	7.5	2.08	480		33.8			29	3.5		
11	3.75	1.04	572	2950	20.8	45	Y225M-2	28	3.0	φ 198	320
	6.3	1.75	550		31.4			30	3.0		
	7.5	2.08	528		37.2			29	3.5		
12	3.75	1.04	624	2950	22.7	55	Y250M-2	28	3.0	φ 198	340
	6.3	1.75	600		34.3			30	3.0		
	7.5	2.08	576		40.6			29	3.5		

CMB 12-25性能曲线

CMB 12-25 Performance Curve

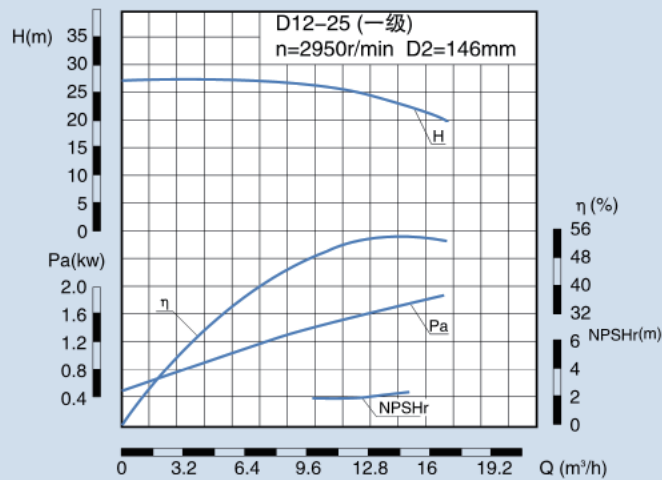

CMB 12-25 性能表

CMB 12-25 Performance Data

级数 Series	流量 Capacity Q		扬程 Head H	转速 Speed n	轴功率 Shaft power Pa	配带电动机 Motor		效率 Eff. η	必需汽 蚀余量 (NPSH) <sub>r</sub>	叶轮名 义直径 Impeller Dia.	泵重 Weight
	m³/h	L/S				功率 Power	型号 Type				
			m	r/min	kW			%	m	mm	kg
2	7.5	2.08	56.4	2950	2.65	5.5	Y132S <sub>1</sub> -2	44	2.0	φ 146	100
	12.5	3.47	50		3.15			54			
	15	4.17	46		3.55			53			
3	7.5	2.08	84.6	2950	3.93	7.5	Y132S <sub>2</sub> -2	44	2.0	φ 146	110
	12.5	3.47	75		4.73			54			
	15	4.17	69		5.32			53			
4	7.5	2.08	112.8	2950	5.24	11	Y160M <sub>1</sub> -2	44	2.0	φ 146	123
	12.5	3.47	100		6.30			54			
	15	4.17	92		7.09			53			
5	7.5	2.08	141	2950	6.55	11	Y160M <sub>1</sub> -2	44	2.0	φ 146	135
	12.5	3.47	125		7.88			54			
	15	4.17	115		8.86			53			
6	7.5	2.08	169.2	2950	7.85	15	Y160M <sub>2</sub> -2	44	2.0	φ 146	148
	12.5	3.47	150		9.46			54			
	15	4.17	138		10.64			53			
7	7.5	2.08	197.4	2950	9.16	15	Y160M <sub>2</sub> -2	44	2.0	φ 146	161
	12.5	3.47	175		11.0			54			
	15	4.17	161		12.41			53			
8	7.5	2.08	225.6	2950	10.47	18.5	Y160L-2	44	2.0	φ 146	174
	12.5	3.47	200		12.61			54			
	15	4.17	184		14.18			53			
9	7.5	2.08	253.8	2950	11.78	18.5	Y160L-2	44	2.0	φ 146	187
	12.5	3.47	225		14.18			54			
	15	4.17	207		15.95			53			
10	7.5	2.08	282	2950	13.09	22	Y180M-2	44	2.0	φ 146	199
	12.5	3.47	250		15.76			54			
	15	4.17	230		17.73			53			
11	7.5	2.08	310.2	2950	14.4	22	Y180M-2	44	2.0	φ 146	212
	12.5	3.47	275		17.34			54			
	15	4.17	253		19.5			53			
12	7.5	2.08	338.4	2950	15.7	30	Y200L <sub>1</sub> -2	44	2.0	φ 146	234
	12.5	3.47	300		18.9			54			
	15	4.17	276		21.3			53			

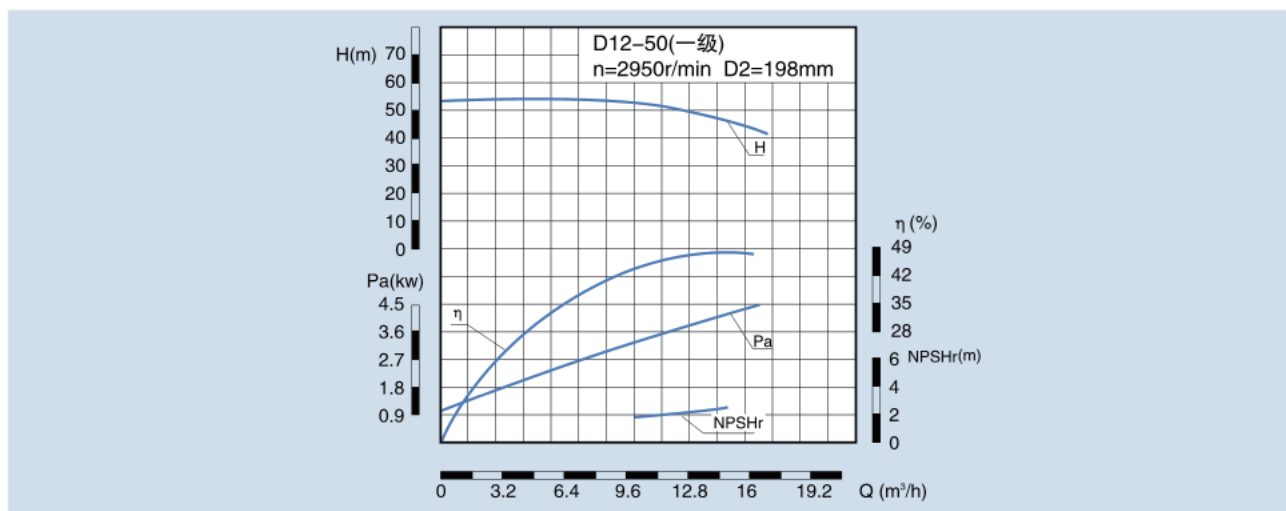
**CMB 12-50性能曲线**
**CMB 12-50 Performance Curve**

**CMB 12-50 性能表**
**CMB 12-50 Performance Data**

级数 Series	流量 Capacity Q		扬程 Head H m	转速 Speed n r/min	轴功率 Shaft power Pa kW	配带电动机 Motor		效率 Eff. η %	必需汽 蚀余量 (NPSH)r m	叶轮名 义直径 Impeller Dia. mm	泵重 Weight kg
	m³/h	L/S				功率 Power kW	型号 Type				
2	7.5	2.08	108	2950	5.8	11	Y160M <sub>1</sub> -2	37.8	2.0	φ 198	160
	12.5	3.47	100		7.6			45	2.0		
	15	4.17	93		8.3			45.9	2.5		
3	7.5	2.08	162	2950	8.8	18.5	Y160L-2	37.8	2.0	φ 198	189
	12.5	3.47	150		11.3			45	2.0		
	15	4.17	139.5		12.4			45.9	2.5		
4	7.5	2.08	216	2950	11.7	22	Y180M-2	37.8	2.0	φ 198	217
	12.5	3.47	200		15.1			45	2.0		
	15	4.17	186		16.6			45.9	2.5		
5	7.5	2.08	270	2950	14.6	30	Y200L <sub>1</sub> -2	37.8	2.0	φ 198	245
	12.5	3.47	250		18.9			45	2.0		
	15	4.17	232.5		20.7			45.9	2.5		
6	7.5	2.08	324	2950	17.6	30	Y200L <sub>1</sub> -2	37.8	2.0	φ 198	273
	12.5	3.47	300		22.7			45	2.0		
	15	4.17	279		24.8			45.9	2.5		
7	7.5	2.08	378	2950	20.4	37	Y200L <sub>2</sub> -2	37.8	2.0	φ 198	301
	12.5	3.47	350		26.5			45	2.0		
	15	4.17	325.5		29.0			45.9	2.5		
8	7.5	2.08	432	2950	23.3	45	Y225M-2	37.8	2.0	φ 198	329
	12.5	3.47	400		30.3			45	2.0		
	15	4.17	372		33.1			45.9	2.5		
9	7.5	2.08	486	2950	26.3	45	Y225M-2	37.8	2.0	φ 198	357
	12.5	3.47	450		34.0			45	2.0		
	15	4.17	418.5		37.3			45.9	2.5		
10	7.5	2.08	540	2950	29.2	55	Y250M-2	37.8	2.0	φ 198	385
	12.5	3.47	500		37.8			45	2.0		
	15	4.17	465		41.4			45.9	2.5		
11	7.5	2.08	594	2950	32.1	55	Y250M-2	37.8	2.0	φ 198	413
	12.5	3.47	550		41.6			45	2.0		
	15	4.17	511.5		45.5			45.9	2.5		
12	7.5	2.08	648	2950	35.0	75	Y280S-2	37.8	2.0	φ 198	441
	12.5	3.47	600		45.4			45	2.0		
	15	4.17	558		50.0			45.9	2.5		

CMB 25-30性能曲线

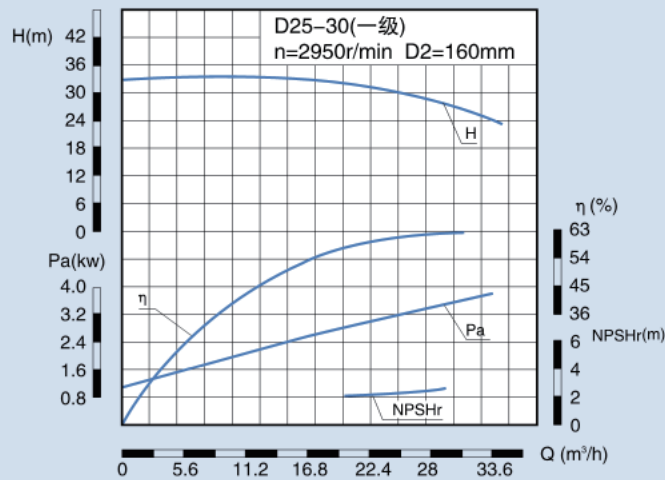
CMB 25-30 Performance Curve



CMB 25-30 性能表

CMB 25-30 Performance Data

级数 Series	流量 Capacity Q		扬程 Head H	转速 Speed n	轴功率 Shaft power Pa	配带电动机 Motor		效率 Eff. η	必需汽 蚀余量 (NPSH) <sub>r</sub>	叶轮名 义直径 Impeller Dia.	泵重 Weight
	m³/h	L/S				功率 Power	型号 Type				
			m	r/min	kW			kW	%	m	mm
2	15	4.17	68	2950	5.56	11	Y160M <sub>1</sub> -2	50	2.2	φ 160	110
	25	6.94	60		6.58			62			
	30	8.33	55		7.14			63			
3	15	4.17	102	2950	8.33	15	Y160M <sub>2</sub> -2	50	2.2	φ 160	130
	25	6.94	90		9.88			62			
	30	8.33	82.5		10.7			63			
4	15	4.17	136	2950	11.11	18.5	Y160L-2	50	2.2	φ 160	150
	25	6.94	120		13.1			62			
	30	8.33	110		14.26			63			
5	15	4.17	170	2950	13.89	22	Y180M-2	50	2.2	φ 160	170
	25	6.94	150		16.47			62			
	30	8.33	137.5		17.83			63			
6	15	4.17	204	2950	16.67	30	Y200L <sub>1</sub> -2	50	2.2	φ 160	190
	25	6.94	180		19.77			62			
	30	8.33	165		21.4			63			
7	15	4.17	238	2950	19.44	30	Y200L <sub>1</sub> -2	50	2.2	φ 160	210
	25	6.94	210		23.1			62			
	30	8.33	192.5		24.96			63			
8	15	4.17	272	2950	22.22	37	Y200L <sub>2</sub> -2	50	2.2	φ 160	230
	25	6.94	240		26.4			62			
	30	8.33	220		28.53			63			
9	15	4.17	306	2950	25.0	37	Y200L <sub>2</sub> -2	50	2.2	φ 160	250
	25	6.94	270		29.65			62			
	30	8.33	247.5		32.1			63			
10	15	4.17	340	2950	27.8	45	Y225M-2	50	2.2	φ 160	270
	25	6.94	300		32.9			62			
	30	8.33	275		35.7			63			

### CMB25-50性能曲线

### CMB25-50 Performance Curve

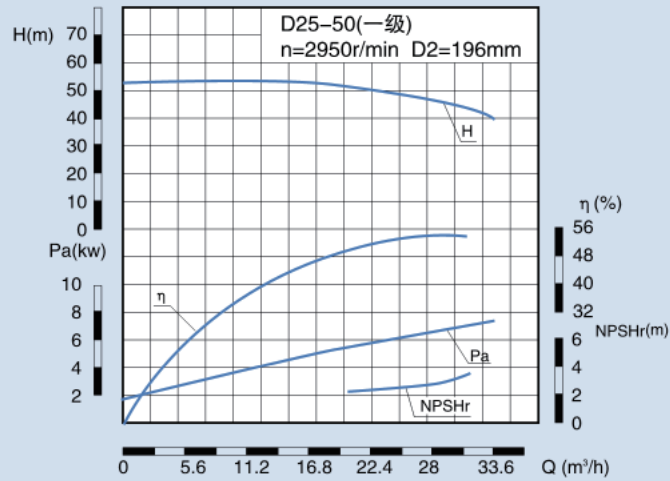

### CMB 25-50 性能表

### CMB 25-50 Performance Data

级数 Series	流量 Capacity Q		扬程 Head H	转速 Speed n	轴功率 Shaft power Pa	配带电动机 Motor		效率 Eff. η	必需汽 蚀余量 (NPSH)r	叶轮名 义直径 Impeller Dia.	泵重 Weight
	m³/h	L/S				功率 Power	型号 Type				
			m	r/min	kW			kW	%	m	mm
3	15	4.17	154.5	2950	14.3	30	Y200L <sub>1</sub> -2	44	2.4	φ 196	220
	25	6.94	150		18.9			54	2.7		
	28	7.78	144		20.3			54	2.8		
4	15	4.17	206	2950	19.1	37	Y200L <sub>2</sub> -2	44	2.4	φ 196	241
	25	6.94	200		25.2			54	2.7		
	28	7.78	192		27.1			54	2.8		
5	15	4.17	257.5	2950	23.9	37	Y200L <sub>2</sub> -2	44	2.4	φ 196	262
	25	6.94	250		31.5			54	2.7		
	28	7.78	240		33.9			54	2.8		
6	15	4.17	309	2950	28.6	45	Y225M-2	44	2.4	φ 196	283
	25	6.94	300		37.8			54	2.7		
	28	7.78	288		40.7			54	2.8		
7	15	4.17	360.5	2950	33.4	55	Y250M-2	44	2.4	φ 196	304
	25	6.94	350		44.1			54	2.7		
	28	7.78	336		47.5			54	2.8		
8	15	4.17	412	2950	38.2	75	Y280S-2	44	2.4	φ 196	325
	25	6.94	400		50.4			54	2.7		
	28	7.78	384		54.2			54	2.8		
9	15	4.17	463.5	2950	43.0	75	Y280S-2	44	2.4	φ 196	346
	25	6.94	450		56.7			54	2.7		
	28	7.78	432		61.0			54	2.8		
10	15	4.17	515	2950	47.7	75	Y280S-2	44	2.4	φ 196	367
	25	6.94	500		63.0			54	2.7		
	28	7.78	480		67.8			54	2.8		
11	15	4.17	566	2950	52.5	90	Y280M-2	44	2.4	φ 196	388
	25	6.94	550		69.3			54	2.7		
	28	7.78	528		74.6			54	2.8		
12	15	4.17	618	2950	57.6	110	Y315S-2	44	2.4	φ 196	409
	25	6.94	600		75.6			54	2.7		
	28	7.78	576		81.4			54	2.8		

CMB 46-30 性能曲线

CMB 46-30 Performance Curve

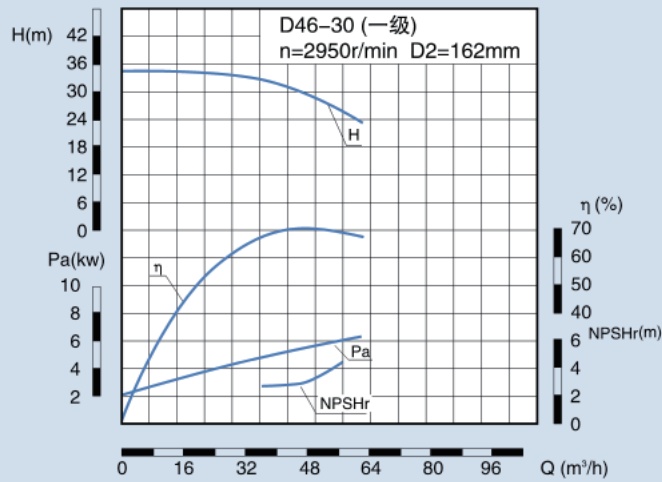

CMB 46-30 性能表

CMB 46-30 Performance Data

级数 Series	流量 Capacity Q		扬程 Head H	转速 Speed n	轴功率 Shaft power Pa	配带电动机 Motor		效率 Eff. η	必需汽 蚀余量 (NPSH) <sub>r</sub>	叶轮名 义直径 Impeller Dia.	泵重 Weight
	m <sup>3</sup> /h	L/S				功率 Power	型号 Type				
			m	r/min	kW			kW	%	m	mm
2	30	8.33	68	2950	8.68	15	Y160M <sub>2</sub> -2	64	2.2	φ 162	165
	46	12.8	60		10.74			70	2.8		
	55	15.3	54		11.89			68	4.6		
3	30	8.33	102	2950	13.02	22	Y180M-2	64	2.2	φ 162	180
	46	12.8	90		16.11			70	2.8		
	55	15.3	81		17.84			68	4.6		
4	30	8.33	136	2950	17.36	30	Y200L <sub>1</sub> -2	64	2.2	φ 162	197
	46	12.8	120		21.48			70	2.8		
	55	15.3	108		23.79			68	4.6		
5	30	8.33	170	2950	21.7	37	Y200L <sub>2</sub> -2	64	2.2	φ 162	214
	46	12.8	150		26.85			70	2.8		
	55	15.3	135		29.74			68	4.6		
6	30	8.33	204	2950	26.04	37	Y200L <sub>2</sub> -2	64	2.2	φ 162	231
	46	12.8	180		32.21			70	2.8		
	55	15.3	162		35.68			68	4.6		
7	30	8.33	238	2950	30.38	45	Y225M-2	64	2.2	φ 162	248
	46	12.8	210		37.58			70	2.8		
	55	15.3	189		41.63			68	4.6		
8	30	8.33	272	2950	34.72	55	Y250M-2	64	2.2	φ 162	265
	46	12.8	240		42.95			70	2.8		
	55	15.3	216		47.58			68	4.6		
9	30	8.33	306	2950	39.06	55	Y250M-2	64	2.2	φ 162	282
	46	12.8	270		48.32			70	2.8		
	55	15.3	243		53.53			68	4.6		
10	30	8.33	340	2950	43.4	75	Y280S-2	64	2.2	φ 162	299
	46	12.8	300		53.69			70	2.8		
	55	15.3	270		59.47			68	4.6		

### CMB46-50性能曲线

### CMB46-50 Performance Curve

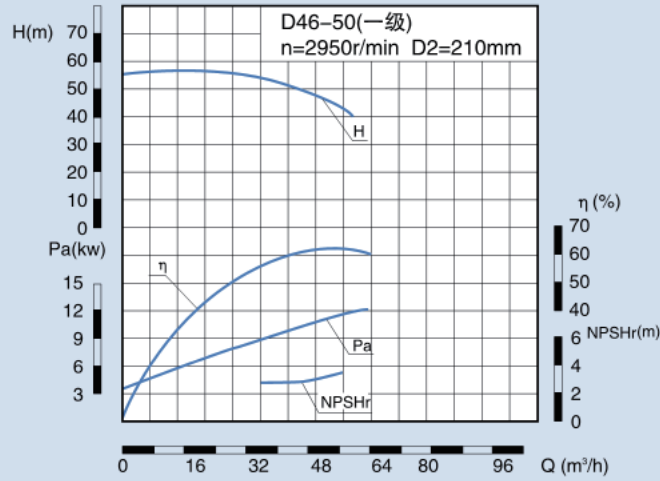

### CMB 46-50 性能表

### CMB 46-50 Performance Data

级数 Series	流量 Capacity Q		扬程 Head H	转速 Speed n	轴功率 Shaft power Pa	配带电动机 Motor		效率 Eff. η	必需汽 蚀余量 (NPSH)r	叶轮名 义直径 Impeller Dia.	泵重 Weight
	m³/h	L/S				功率 Power	型号 Type				
			m	r/min	kW			kW	%	m	mm
2	30	8.33	111	2950	16.78	30	Y200L <sub>1</sub> -2	54	2.5	φ 210	255
	46	12.78	100		19.88			63	2.8		
	55	15.28	92		21.52			64	3.2		
3	30	8.33	166.5	2950	25.19	37	Y200L <sub>2</sub> -2	54	2.5	φ 210	270
	46	12.78	150		29.83			63	2.8		
	55	15.28	138		32.28			64	3.2		
4	30	8.33	222	2950	33.59	45	Y225M-2	54	2.5	φ 210	295
	46	12.78	200		39.77			63	2.8		
	55	15.28	184		43.04			64	3.2		
5	30	8.33	277.5	2950	41.98	55	Y250M-2	54	2.5	φ 210	315
	46	12.78	250		49.71			63	2.8		
	55	15.28	230		53.80			64	3.2		
6	30	8.33	333	2950	50.38	75	Y280S-2	54	2.5	φ 210	340
	46	12.78	300		59.65			63	2.8		
	55	15.28	276		64.56			64	3.2		
7	30	8.33	388.5	2950	58.78	90	Y280M-2	54	2.5	φ 210	360
	46	12.78	350		69.60			63	2.8		
	55	15.28	322		75.32			64	3.2		
8	30	8.33	444	2950	67.20	90	Y280M-2	54	2.5	φ 210	385
	46	12.78	400		79.52			63	2.8		
	55	15.28	368		86.08			64	3.2		
9	30	8.33	499.5	2950	75.56	110	Y315S-2	54	2.5	φ 210	405
	46	12.78	450		89.48			63	2.8		
	55	15.28	414		96.84			64	3.2		
10	30	8.33	555	2950	83.97	132	Y315M-2	54	2.5	φ 210	430
	46	12.78	500		99.42			63	2.8		
	55	15.28	460		107.60			64	3.2		
11	30	8.33	610.5	2950	92.37	132	Y315M-2	54	2.5	φ 210	450
	46	12.78	550		109.36			63	2.8		
	55	15.28	506		118.36			64	3.2		
12	30	8.33	666	2950	100.8	160	Y315L <sub>1</sub> -2	54	2.5	φ 210	475
	46	12.78	600		119.28			63	2.8		
	55	15.28	552		129.12			64	3.2		

CMB 80-30 性能曲线

CMB 80-30 Performance Curve

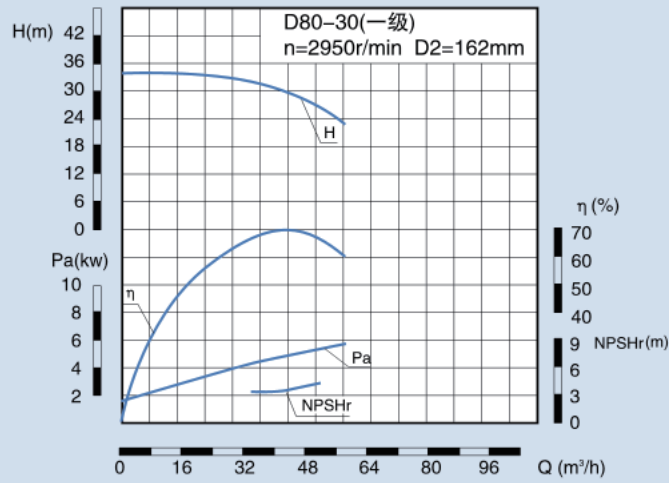

CMB 80-30 性能表

CMB 80-30 Performance Data

级数 Series	流量 Capacity		扬程 Head H	转速 Speed n	轴功率 Shaft power Pa	配带电动机 Motor		效率 Eff. η	必需汽 蚀余量 (NPSH)r	叶轮名 义直径 Impeller Dia. mm	泵重 Weight kg
	Q					功率 Power kW	型号 Type				
	m³/h	L/S	m	r/min	kW			%	m		
3	26	7.22	102	2950	12.0	18.5	Y160L-2	60	3.0	φ 162	145
	43	11.94	90		15.1			70			
	48	13.33	83		15.7			69			
4	26	7.22	136	2950	16.0	22	Y180M-2	60	3.0	φ 162	163
	43	11.94	120		20.1			70			
	48	13.33	111		20.96			69			
5	26	7.22	170	2950	20.1	30	Y200L <sub>1</sub> -2	60	3.0	φ 162	181
	43	11.94	150		25.2			70			
	48	13.33	139		26.2			69			
6	26	7.22	204	2950	24.1	37	Y200L <sub>2</sub> -2	60	3.0	φ 162	200
	43	11.94	180		30.2			70			
	48	13.33	167		31.44			69			
7	26	7.22	238	2950	28.1	45	Y225M-2	60	3.0	φ 162	218
	43	11.94	210		35.2			70			
	48	13.33	195		36.68			69			
8	26	7.22	272	2950	32.1	55	Y250M-2	60	3.0	φ 162	236
	43	11.94	240		40.2			70			
	48	13.33	222		41.96			69			
9	26	7.22	306	2950	36.1	55	Y250M-2	60	3.0	φ 162	255
	43	11.94	270		45.3			70			
	48	13.33	250		47.16			69			
10	26	7.22	340	2950	40.1	55	Y250M-2	60	3.0	φ 162	275
	43	11.94	300		50.3			70			
	48	13.33	278		53.0			69			

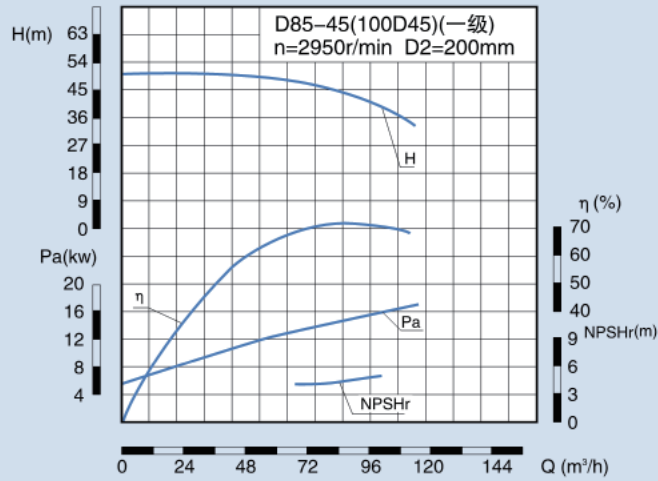
**CMB 85-45(100 45) 性能曲线**
**CMB 85-45(100 45) Performance Curve**

**CMB 85-45(100 45) 性能参数表**
**CMB 85-45(100 45) Performance Data**

级数 Series	流量 Capacity Q		扬程 Head H m	转速 Speed n r/min	轴功率 Shaft power Pa kW	配带电动机 Motor		效率 Eff. η %	必需汽 蚀余量 (NPSH)r m	叶轮名 义直径 Impeller Dia. mm	泵重 Weight kg
	m³/h	L/S				功率 Power kW	型号 Type				
2	55	15.3	102	2950	24.25	37	Y200L <sub>2</sub> -2	63	3.2	φ 200	225
	85	23.6	90		28.92						
	100	27.8	78		30.35						
3	55	15.3	153	2950	36.38	55	Y250M-2	63	3.2	φ 200	250
	85	23.6	135		43.37						
	100	27.8	117		45.52						
4	55	15.3	204	2950	48.5	75	Y280S-2	63	3.2	φ 200	275
	85	23.6	180		57.82						
	100	27.8	156		60.7						
5	55	15.3	255	2950	60.63	90	Y280M-2	63	3.2	φ 200	300
	85	23.6	225		72.28						
	100	27.8	195		75.86						
6	55	15.3	306	2950	72.75	110	Y315S-2	63	3.2	φ 200	325
	85	23.6	270		86.73						
	100	27.8	234		91.04						
7	55	15.3	357	2950	84.88	132	Y315M-2	63	3.2	φ 200	350
	85	23.6	315		101.2						
	100	27.8	273		106.2						
8	55	15.3	408	2950	97.0	132	Y315M-2	63	3.2	φ 200	375
	85	23.6	360		115.6						
	100	27.8	312		121.4						
9	55	15.3	459	2950	109.1	160	Y315L <sub>1</sub> -2	63	3.2	φ 200	400
	85	23.6	405		130.1						
	100	27.8	351		136.6						

CMB 85-67性能曲线

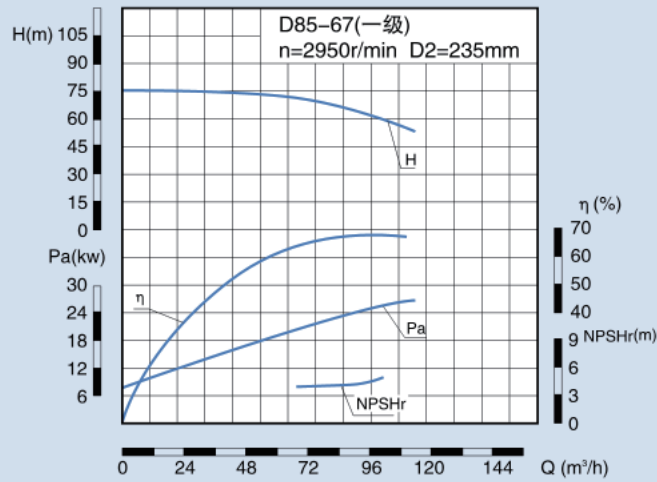
CMB 85-67 Performance Curve



CMB 85-67 性能表

CMB 85-67 Performance Data

级数 Series	流量 Capacity Q		扬程 Head H	转速 Speed n	轴功率 Shaft power Pa	配带电动机 Motor		效率 Eff. η	必需汽 蚀余量 (NPSH)r	叶轮名 义直径 Impeller Dia.	泵重 Weight
	m³/h	L/S				功率 Power	型号 Type				
					%			m	mm	kg	
3	55	15.3	222	2950	57.3	90	Y280M-2	58	3.3	φ 235	846
	85	23.6	201		68.4			68	4.0		
	100	27.8	183		73.3			68	4.4		
4	55	15.3	296	2950	76.4	110	Y315S-2	58	3.3	φ 235	964
	85	23.6	268		91.2			68	4.0		
	100	27.8	244		97.7			68	4.4		
5	55	15.3	370	2950	95.6	132	Y315M-2	58	3.3	φ 235	1126
	85	23.6	335		114			68	4.0		
	100	27.8	305		122.2			68	4.4		
6	55	15.3	444	2950	114.7	160	Y315L <sub>1</sub> -2	58	3.3	φ 235	1434
	85	23.6	402		136.9			68	4.0		
	100	27.8	366		146.6			68	4.4		
7	55	15.3	518	2950	133.8	185	Y315L-2	58	3.3	φ 235	1556
	85	23.6	469		159.6			68	4.0		
	100	27.8	427		171			68	4.4		
8	55	15.3	592	2950	152.9	220	Y355M <sub>1</sub> -2	58	3.3	φ 235	1624
	85	23.6	536		182.4			68	4.0		
	100	27.8	488		195.4			68	4.4		
9	55	15.3	666	2950	172	250	Y355M <sub>2</sub> -2	58	3.3	φ 235	1840
	85	23.6	603		205.2			68	4.0		
	100	27.8	549		219.9			68	4.4		

### CMB 120-50性能曲线

### CMB 120-50 Performance Curve

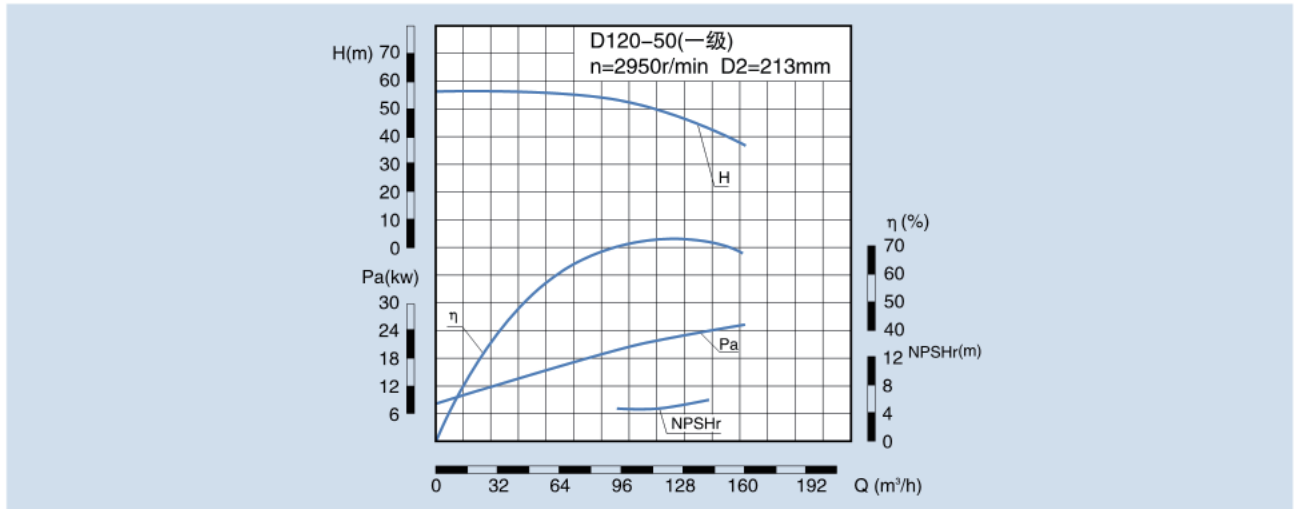

### CMB 120-50 性能表

### CMB 120-50 Performance Data

级数 Series	流量 Capacity Q		扬程 Head H	转速 Speed n	轴功率 Shaft power Pa	配带电动机 Motor		效率 Eff. η	必需汽 蚀余量 (NPSH)r	叶轮名 义直径 Impeller Dia.	泵重 Weight
	m³/h	L/S				功率 Power	型号 Type				
			m	r/min	kW			kW	%	m	mm
2	96	26.7	110	2950	39.44	55	Y250M-2	73	3.2	φ 213	640
	120	33.3	100		44.54			73.3	5.1		
	140	38.9	84.6		48.8			67.5	6.7		
3	96	26.7	165	2950	59.09	90	Y280M-2	73	3.2	φ 213	720
	120	33.3	150		66.88			73.3	5.1		
	140	38.9	126.9		71.68			67.5	6.7		
4	96	26.7	220	2950	78.79	110	Y315S-2	73	3.2	φ 213	800
	120	33.3	200		89.17			73.3	5.1		
	140	38.9	169.2		95.57			67.5	6.7		
5	96	26.7	275	2950	98.49	132	Y315M-2	73	3.2	φ 213	880
	120	33.3	250		111.46			73.3	5.1		
	140	38.9	211.5		119.46			67.5	6.7		
6	96	26.7	330	2950	118.18	160	Y315L <sub>1</sub> -2	73	3.2	φ 213	960
	120	33.3	300		133.75			73.3	5.1		
	140	38.9	253.8		143.36			67.5	6.7		
7	96	26.7	385	2950	137.88	200	Y315L <sub>2</sub> -2	73	3.2	φ 213	1040
	120	33.3	350		156.04			73.3	5.1		
	140	38.9	296.1		167.25			67.5	6.7		
8	96	26.7	440	2950	157.58	200	Y315L <sub>2</sub> -2	73	3.2	φ 213	1120
	120	33.3	400		178.33			73.3	5.1		
	140	38.9	338.4		191.14			67.5	6.7		
9	96	26.7	495	2950	177.28	220	Y355M <sub>1</sub> -2	73	3.2	φ 213	1200
	120	33.3	450		200.63			73.3	5.1		
	140	38.9	380.7		215.03			67.5	6.7		

CMB 155-30(150 30) 性能曲线

CMB 155-30(150 30) Performance Curve

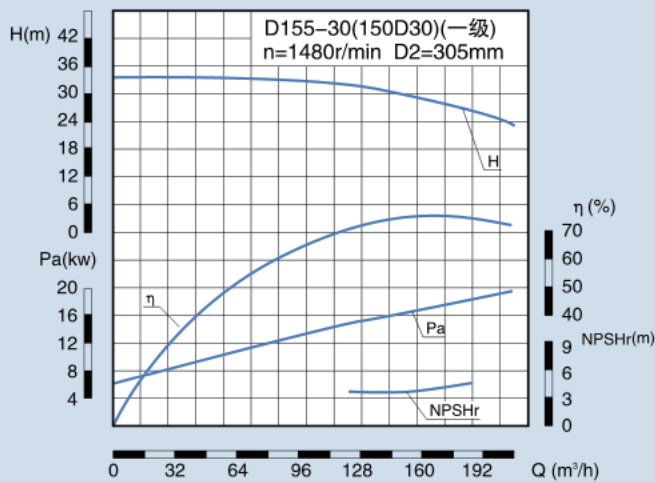

CMB 155-30(150 30) 性能表

CMB 155-30(150 30) Performance Data

级数 Series	流量 Capacity Q		扬程 Head H	转速 Speed n	轴功率 Shaft power Pa	配带电动机 Motor		效率 Eff. η	必需汽 蚀余量 (NPSH)r	叶轮名 义直径 Impeller Dia.	泵重 Weight
	m³/h	L/S				功率 Power	型号 Type				
			m	r/min	kW			kW	%	m	mm
2	119	33	64	1480	29.8	45	Y225M-4	69.5	3.2	φ 305	490
	155	43	60		33.71			75	3.9		
	190	52.8	54		36.95			76	4.8		
3	119	33	96	1480	44.7	75	Y280S-4	69.5	3.2	φ 305	575
	155	43	90		50.57			75	3.9		
	190	52.8	81		55.42			76	4.8		
4	119	33	128	1480	59.6	90	Y280M-4	69.5	3.2	φ 305	660
	155	43	120		67.42			75	3.9		
	190	52.8	108		73.9			76	4.8		
5	119	33	160	1480	74.5	110	Y315S-4	69.5	3.2	φ 305	750
	155	43	150		84.28			75	3.9		
	190	52.8	135		92.37			76	4.8		
6	119	33	192	1480	89.4	132	Y315M-4	69.5	3.2	φ 305	840
	155	43	180		101.1			75	3.9		
	190	52.8	162		110.8			76	4.8		
7	119	33	224	1480	104.3	160	Y315L1-4	69.5	3.2	φ 305	930
	155	43	210		118.0			75	3.9		
	190	52.8	189		129.3			76	4.8		
8	119	33	256	1480	119.2	200	Y315L2-4	69.5	3.2	φ 305	1020
	155	43	240		134.8			75	3.9		
	190	52.8	216		147.8			76	4.8		
9	119	33	288	1480	134.1	200	Y315L2-4	69.5	3.2	φ 305	1110
	155	43	270		151.7			75	3.9		
	190	52.8	243		166.3			76	4.8		
10	119	33	320	1480	149	220	Y355M1-4	69.5	3.2	φ 305	1200
	155	43	300		168.6			75	3.9		
	190	52.8	270		184.7			76	4.8		

### CMB155-67 性能曲线

### CMB155-67 Performance Curve

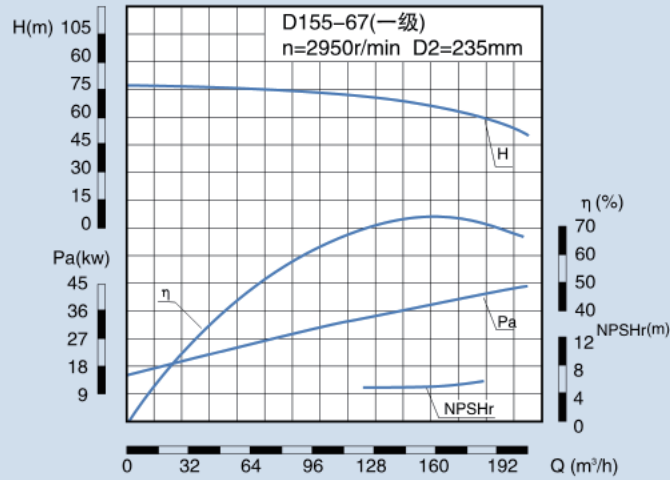

### CMB 155-67 性能表

### CMB 155-67 Performance Data

级数 Series	流量 Capacity Q		扬程 Head H m	转速 Speed n r/min	轴功率 Shaft power Pa kW	配带电动机 Motor		效率 Eff. η %	必需汽 蚀余量 (NPSH)r m	叶轮名 义直径 Impeller Dia. mm	泵重 Weight kg	
	m³/h	L/S				功率 Power kW	型号 Type					
2	100	27.8	152	2950	64.7	90	Y280M-2	64	3.2	φ 235	880	
	155	43.1	134		76.5			74				5.0
	185	51.4	118		82.6			72				6.6
3	100	27.8	228	2950	97.0	132	Y315M-2	64	3.2	φ 235	952	
	155	43.1	201		114.7			74				5.0
	185	51.4	177		123.9			72				6.6
4	100	27.8	304	2950	129.4	185	Y315L-2	64	3.2	φ 235	1024	
	155	43.1	268		152.9			74				5.0
	185	51.4	236		165.1			72				6.6
5	100	27.8	380	2950	161.7	220	Y355M <sub>1</sub> -2	64	3.2	φ 235	1145	
	155	43.1	335		191.2			74				5.0
	185	51.4	295		206.4			72				6.6
6	100	27.8	456	2950	194	280	Y355L <sub>1</sub> -2	64	3.2	φ 235	1435	
	155	43.1	402		229.5			74				5.0
	185	51.4	354		247.7			72				6.6
7	100	27.8	532	2950	226.4	315	Y355L <sub>2</sub> -2	64	3.2	φ 235	1558	
	155	43.1	469		267.7			74				5.0
	185	51.4	413		288.9			72				6.6
8	100	27.8	608	2950	258.8	355	Y3552-2	64	3.2	φ 235	1700	
	155	43.1	536		305.9			74				5.0
	185	51.4	472		330.2			72				6.6
9	100	27.8	684	2950	291.1	450	Y4001-2	64	3.2	φ 235	1860	
	155	43.1	603		344.2			74				5.0
	185	51.4	531		371.5			72				6.6

CMB 280-43(200 43) 性能曲线

CMB 280-43(200 43) Performance Curve

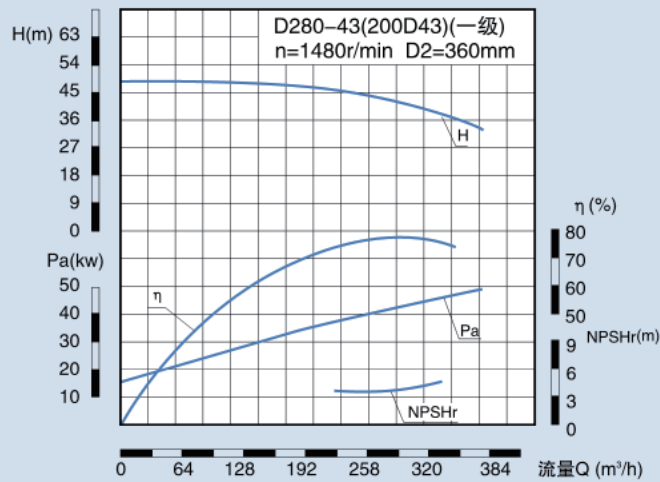

CMB 280-43(200 43) 性能表

CMB 280-43(200 43) Performance Data

级数 Series	流量 Capacity Q		扬程 Head H	转速 Speed n	轴功率 Shaft power Pa	配带电动机 Motor		效率 Eff. η	必需汽 蚀余量 (NPSH) <sub>r</sub>	叶轮名 义直径 Impeller Dia.	泵重 Weight
	m <sup>3</sup> /h	L/S				功率 Power	型号 Type				
					%			m	mm	kg	
2	185	51.4	94	1480	68.6	110	Y315S-4	69	2.5	φ 360	667
	280	77.8	86		85.2			77	4.0		
	335	93.1	76		92.5			75	5.2		
3	185	51.4	141	1480	102.9	160	Y315L <sub>1</sub> -4	69	2.5	φ 360	787
	280	77.8	129		127.7			77	4.0		
	335	93.1	114		138.8			75	5.2		
4	185	51.4	188	1480	137.7	200	Y315L <sub>2</sub> -4	69	2.5	φ 360	908
	280	77.8	172		170.3			77	4.0		
	335	93.1	152		185.0			75	5.2		
5	185	51.4	235	1480	171.6	250	Y355M <sub>2</sub> -4	69	2.5	φ 360	1028
	280	77.8	215		212.9			77	4.0		
	335	93.1	190		231.3			75	5.2		
6	185	51.4	282	1480	205.9	315	Y355L <sub>2</sub> -4	69	2.5	φ 360	1149
	280	77.8	258		255.5			77	4.0		
	335	93.1	228		277.5			75	5.2		
7	185	51.4	329	1480	240.2	355	Y4001-4	69	2.5	φ 360	1270
	280	77.8	301		298.1			77	4.0		
	335	93.1	266		323.8			75	5.2		
8	185	51.4	376	1480	274.5	400	Y4002-4	69	2.5	φ 360	1390
	280	77.8	344		340.7			77	4.0		
	335	93.1	304		370.0			75	5.2		
9	185	51.4	423	1480	308.8	450	Y4003-4	69	2.5	φ 360	1512
	280	77.8	387		383.3			77	4.0		
	335	93.1	342		416.3			75	5.2		

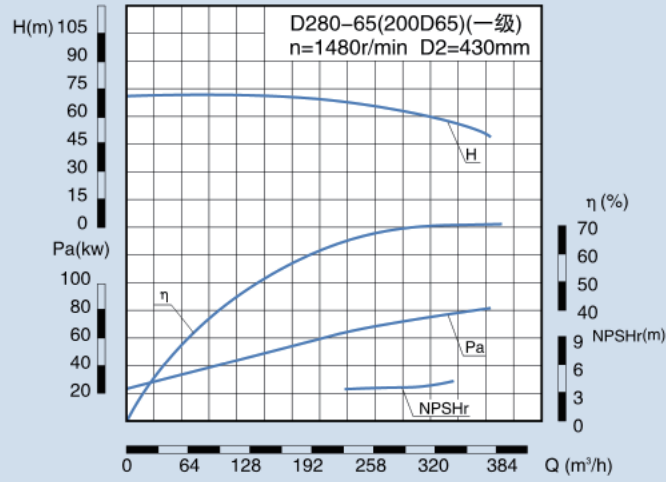
**CMB 280-65(200 65) 性能曲线**
**CMB280-65(200 65) Performance Curve**

**CMB 280-65(200 65) 性能表**
**CMB 280-65(200 65) Performance Data**

级数 Series	流量 Capacity Q		扬程 Head H	转速 Speed n	轴功率 Shaft power Pa	配带电动机 Motor		效率 Eff. η	必需汽 蚀余量 (NPSH)r	叶轮名 义直径 Impeller Dia.	泵重 Weight	
	m³/h	L/S				功率 Power	型号 Type					
			m	r/min	kW			kW	%	m	mm	kg
3	185	51.4	204	1480	180	280	Y3555-4	57	2.0	φ 430	1006	
	280	77.8	195		215			69				3.7
	335	93.1	186		239			71				5.0
4	185	51.4	272	1480	240	355	Y4001-4	57	2.0	φ 430	1188	
	280	77.8	260		287			69				3.7
	335	93.1	248		319			71				5.0
5	185	51.4	340	1480	300	450	Y4003-4	57	2.0	φ 430	1370	
	280	77.8	325		359			69				3.7
	335	93.1	310		398			71				5.0
6	185	51.4	408	1480	361	500	Y4004-4	57	2.0	φ 430	1552	
	280	77.8	390		431			69				3.7
	335	93.1	372		478			71				5.0
7	185	51.4	476	1480	421	630	Y4501-4	57	2.0	φ 430	1734	
	280	77.8	455		503			69				3.7
	335	93.1	434		558			71				5.0
8	185	51.4	544	1480	481	710	Y4502-4	57	2.0	φ 430	1916	
	280	77.8	520		575			69				3.7
	335	93.1	496		637			71				5.0
9	185	51.4	612	1480	541	800	Y4503-4	57	2.0	φ 430	2098	
	280	77.8	585		646			69				3.7
	335	93.1	558		717			71				5.0
10	185	51.4	680	1480	601	900	Y4504-4	57	2.0	φ 430	2280	
	280	77.8	650		718			69				3.7
	335	93.1	620		797			71				5.0

CMB 360-40 性能曲线

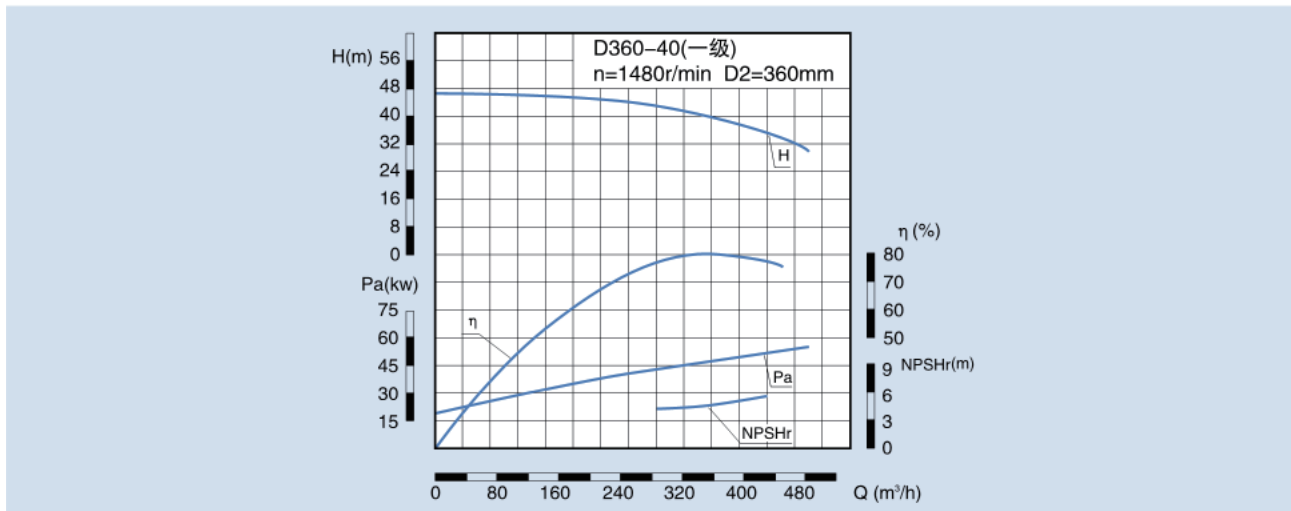
CMB 360-40 Performance Curve



CMB 360-40 性能表

CMB 360-40 Performance Data

级数 Series	流量 Capacity Q		扬程 Head H	转速 Speed n	轴功率 Shaft power Pa	配带电动机 Motor		效率 Eff. η	必需汽 蚀余量 (NPSH)r	叶轮名 义直径 Impeller Dia.	泵重 Weight
	m³/h	L/S				功率 Power	型号 Type				
			m	r/min	kW			kW	%	m	mm
2	300	83.3	84	1480	89.1	132	Y315M1-4	77	4.65	φ 360	950
	360	100	80		98.1			80	4.7		
	440	122.2	71		110.5			77	5.4		
3	300	83.3	126	1480	133.7	185	Y315M1-4	77	4.65	φ 360	1150
	360	100	120		147.2			80	4.7		
	440	122.2	106.5		165.8			77	5.4		
4	300	83.3	168	1480	178.2	250	Y355M2-4	77	4.65	φ 360	1350
	360	100	160		196.2			80	4.7		
	440	122.2	142		221.1			77	5.4		
5	300	83.3	210	1480	222.8	315	Y355L2-4	77	4.65	φ 360	1550
	360	100	200		245.3			80	4.7		
	440	122.2	177.5		276.3			77	5.4		
6	300	83.3	252	1480	257.4	400	Y4002-4	77	4.65	φ 360	1750
	360	100	240		294.1			80	4.7		
	440	122.2	213		331.5			77	5.4		
7	300	83.3	294	1480	311.9	450	Y4003-4	77	4.65	φ 360	1950
	360	100	280		343.1			80	4.7		
	440	122.2	248.5		386.7			77	5.4		
8	300	83.3	336	1480	356.5	500	Y4004-4	77	4.65	φ 360	2150
	360	100	320		392.2			80	4.7		
	440	122.2	284		441.9			77	5.4		
9	300	83.3	378	1480	401.1	560	Y4005-4	77	4.65	φ 360	2350
	360	100	360		441.2			80	4.7		
	440	122.2	319.5		497.2			77	5.4		
10	300	83.3	420	1480	445.6	630	Y4501-4	77	4.65	φ 360	2550
	360	100	400		490.2			80	4.7		
	440	122.2	355		552.4			77	5.4		

### CMB450-60(250 60) 性能曲线

### CMB450-60(250 60) Performance Data

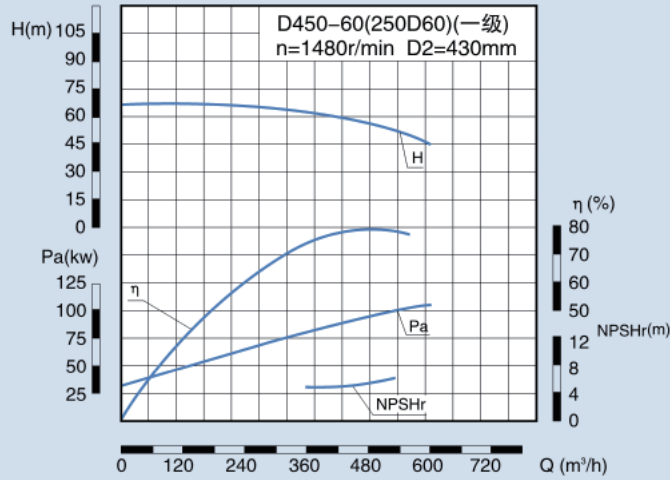

### CMB450-60(250 60) 性能表

### CMB 450-60(250 60) Performance Data

级数 Series	流量 Capacity Q		扬程 Head H	转速 Speed n	轴功率 Shaft power Pa	配带电动机 Motor		效率 Eff. η	必需汽 蚀余量 (NPSH)r	叶轮名 义直径 Impeller Dia.	泵重 Weight
	m³/h	L/S				功率 Power	型号 Type				
			%	m	mm			kg			
2	335	93.1	130	1480	164.7	250	Y3554-4	72	4.1	φ 430	1500
	450	125	120		186.1			79	5.2		
	500	138.9	113		197.3			78	6.3		
3	335	93.1	195	1480	247.1	355	Y4001-4	72	4.1	φ 430	1750
	450	125	180		279.2			79	5.2		
	500	138.9	171		296.0			78	6.3		
4	335	93.1	260	1480	329.5	450	Y4003-4	72	4.1	φ 430	2000
	450	125	240		372.2			79	5.2		
	500	138.9	228		394.7			78	6.3		
5	335	93.1	325	1480	411.8	560	Y4005-4	72	4.1	φ 430	2250
	450	125	300		465.4			79	5.2		
	500	138.9	285		493.4			78	6.3		
6	335	93.1	390	1480	494.2	710	Y4502-4	72	4.1	φ 430	2500
	450	125	360		558.3			79	5.2		
	500	138.9	342		592.0			78	6.3		
7	335	93.1	455	1480	576.5	800	Y4503-4	72	4.1	φ 430	2750
	450	125	420		651.5			79	5.2		
	500	138.9	399		690.7			78	6.3		
8	335	93.1	520	1480	658.9	900	Y4504-4	72	4.1	φ 430	3000
	450	125	480		744.4			79	5.2		
	500	138.9	456		789.4			78	6.3		
9	335	93.1	585	1480	741.2	1000	Y5001-4	72	4.1	φ 430	3250
	450	125	540		837.5			79	5.2		
	500	138.9	513		888.0			78	6.3		
10	335	93.1	650	1480	823.6	1120	Y5002-4	72	4.1	φ 430	3500
	450	125	600		930.8			79	5.2		
	500	138.9	570		995.1			78	6.3		

CMB 550-50 性能曲线

CMB 550-50 Performance Curve

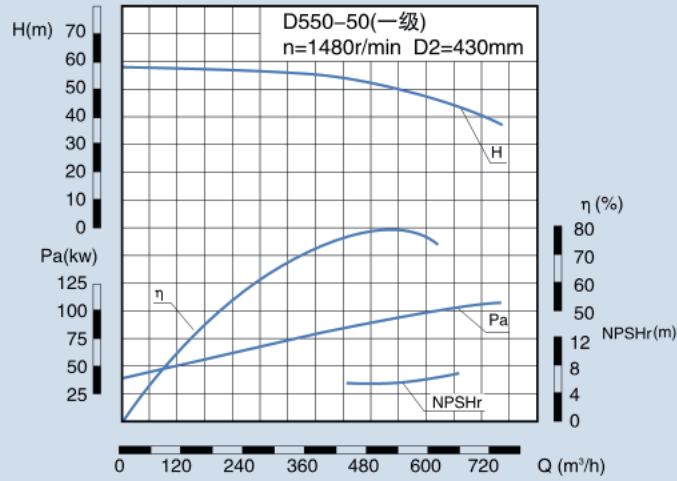

CMB 550-50 性能表

CMB 550-50 Performance Data

级数 Series	流量 Capacity		扬程 Head	转速 Speed	轴功率 Shaft power	配带电动机 Motor		效率 Eff.	必需汽 蚀余量	叶轮名 义直径	泵重 Weight	
	Q		H	n	Pa	功率 Power	型号 Type	η	(NPSH)r	Impeller Dia.	kg	
	m³/h	L/S	m	r/min	kW	kW		%	m	mm		
2	450	125	120	1480	188.5	250	Y3554-4	78	5.2	φ 430	1800	
	550	152.7	100		189.6			79				5.8
	590	163.9	90		192.7			75				6.5
3	450	125	180	1480	282.8	355	Y4001-4	78	5.2	φ 430	2100	
	550	152.7	150		284.3			79				5.8
	590	163.9	135		289.1			75				6.5
4	450	125	240	1480	376.9	450	Y4003-4	78	5.2	φ 430	2400	
	550	152.7	200		378.9			79				5.8
	590	163.9	180		385.4			75				6.5
5	450	125	300	1480	471.3	560	Y4005-4	78	5.2	φ 430	2700	
	550	152.7	250		473.8			79				5.8
	590	163.9	225		481.8			75				6.5
6	450	125	360	1480	565.5	710	Y4502-4	78	5.2	φ 430	3000	
	550	152.7	300		568.5			79				5.8
	590	163.9	270		578.1			75				6.5
7	450	125	420	1480	659.8	800	Y4503-4	78	5.2	φ 430	3300	
	550	152.7	350		663.3			79				5.8
	590	163.9	315		674.5			75				6.5
8	450	125	480	1480	754.0	900	Y4504-4	78	5.2	φ 430	3600	
	550	152.7	400		758.0			79				5.8
	590	163.9	360		770.8			75				6.5
9	450	125	540	1480	848.3	1000	Y5001-4	78	5.2	φ 430	3900	
	550	152.7	450		852.8			79				5.8
	590	163.9	405		867.2			75				6.5

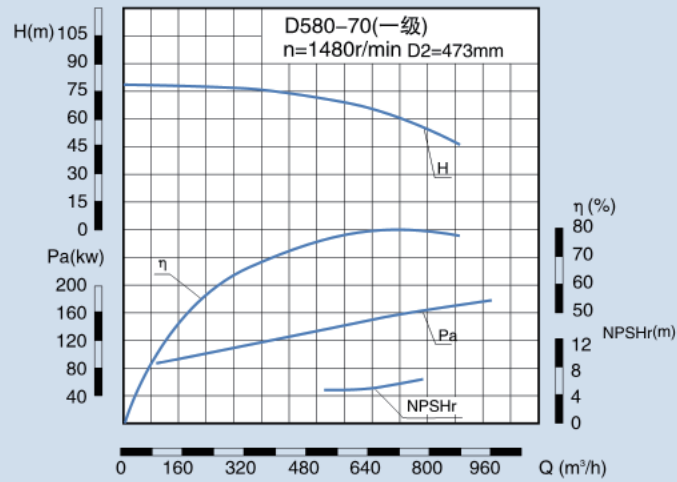
**CMB580-70性能曲线表**
**CMB 580-70 Performance Curve**

**CMB580-70性能表**
**CMB 580-70 Performance Data**

级数 Series	流量 Capacity Q		扬程 Head H	转速 Speed n	轴功率 Shaft power Pa	配带电动机 Motor		效率 Eff. η	必需汽 蚀余量 (NPSH)r	叶轮名 义直径 Impeller Dia.	泵重 Weight
	m³/h	L/S				功率 Power	型号 Type				
					%			m	mm	kg	
3	500	138.9	219.6	1480	399	560	Y4005-4	75	4.4	φ 473	1950
	580	161.1	210		425			78	5.2		
	720	200	192		470			80	8.2		
4	500	138.9	292.8	1480	532	710	Y4502-4	75	4.4	φ 473	2260
	580	161.1	280		567			78	5.2		
	720	200	256		627			80	8.2		
5	500	138.9	366	1480	665	900	Y4504-4	75	4.4	φ 473	2570
	580	161.1	350		709			78	5.2		
	720	200	320		784			80	8.2		
6	500	138.9	439.2	1480	797	1120	Y5002-4	75	4.4	φ 473	2880
	580	161.1	420		851			78	5.2		
	720	200	384		941			80	8.2		
7	500	138.9	512.4	1480	930	1250	Y5003-4	75	4.4	φ 473	3190
	580	161.1	490		992			78	5.2		
	720	200	448		1098			80	8.2		
8	500	138.9	585.6	1480	1063	1400	Y5004-4	75	4.4	φ 473	3500
	580	161.1	560		1134			78	5.2		
	720	200	512		1255			80	8.2		
9	500	138.9	658.8	1480	1196	1600	Y5601-4	75	4.4	φ 473	3810
	580	161.1	630		1276			78	5.2		
	720	200	576		1412			80	8.2		
10	500	138.9	732	1480	1329	1800	Y5062-4	75	4.4	φ 473	4120
	580	161.1	700		1418			78	5.2		
	720	200	640		1569			80	8.2		

CMB 600-60性能曲线表

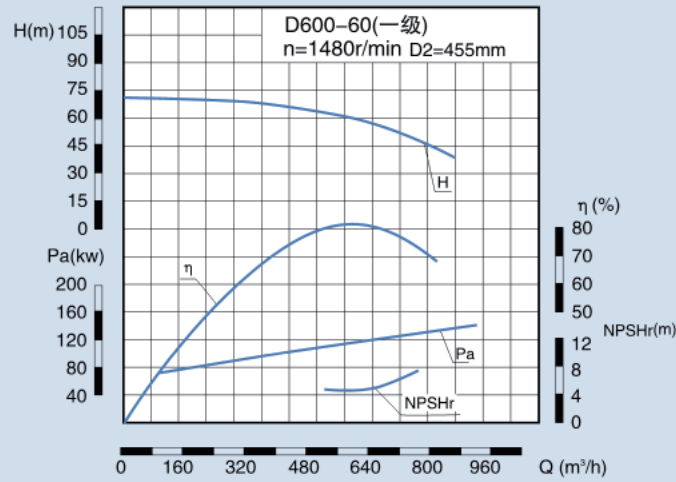
CMB 600-60 Performance Curve



CMB600-60性能表

CMB 600-60 Performance Data

级数 Series	流量 Capacity Q		扬程 Head H	转速 Speed n	轴功率 Shaft power Pa	配带电动机 Motor		效率 Eff. η	必需汽 蚀余量 (NPSH)r	叶轮名 义直径 Impeller Dia.	泵重 Weight
	m³/h	L/S				功率 Power	型号 Type				
					%			m	mm	kg	
3	450	125	195	1480	321.6	450	Y4003-4	79	4.5	φ 455	2300
	600	166.6	180		358.2			82			
	638	177.2	165		362.4			79			
4	450	125	260	1480	428.8	560	Y4005-4	79	4.5	φ 455	2650
	600	166.6	240		477.6			82			
	638	177.2	220		483.2			79			
5	450	125	325	1480	536	710	Y4502-4	79	4.5	φ 455	3000
	600	166.6	300		597			82			
	638	177.2	275		604			79			
6	450	125	390	1480	643.2	800	Y4503-4	79	4.5	φ 455	3350
	600	166.6	360		716.4			82			
	638	177.2	330		724.8			79			
7	450	125	455	1480	750.4	900	Y4504-4	79	4.5	φ 455	3700
	600	166.6	420		835.8			82			
	638	177.2	385		845.6			79			
8	450	125	520	1480	857.6	1120	Y5002-4	79	4.5	φ 455	4050
	600	166.6	480		955.2			82			
	638	177.2	440		966.4			79			
9	450	125	585	1480	964.8	1250	Y5003-4	79	4.5	φ 455	4400
	600	166.6	540		1074.6			82			
	638	177.2	495		1087.2			79			
10	450	125	650	1480	1072	1400	Y5004-4	79	4.5	φ 455	4750
	600	166.6	600		1194			82			
	638	177.2	550		1208			79			

### CMB720-60 性能曲线

### CMB720-60 Performance Curve

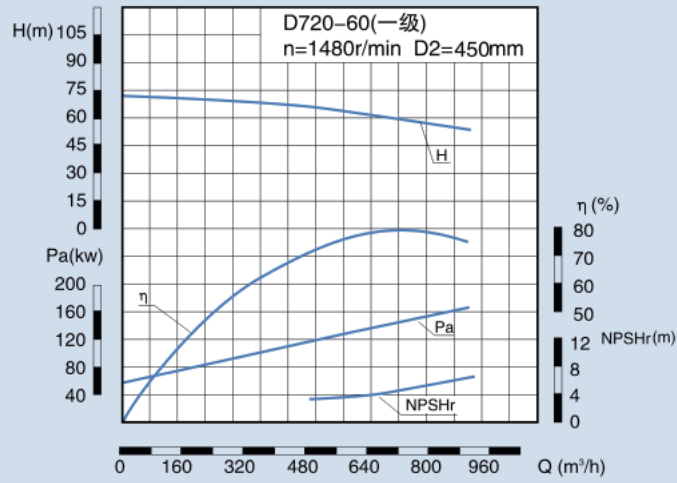

### CMB 720-60 性能表

### CMB 720-60 Performance Data

级数 Series	流量 Capacity Q		扬程 Head H	转速 Speed n	轴功率 Shaft power Pa	配带电动机 Motor		效率 Eff. η	必需汽 蚀余量 (NPSH)r	叶轮名 义直径 Impeller Dia.	泵重 Weight
	m³/h	L/S				功率 Power	型号 Type				
					%			m	mm	kg	
2	550	152.8	132	1480	263.6	400	Y4002-4	75	3.5	φ 450	1830
	720	200	120		286.9			82	4.5		
	850	236.1	114		329.9			80	5.5		
3	550	152.8	198	1480	310.59	560	Y4005-4	75	3.5	φ 450	2040
	720	200	180		430.42			82	4.5		
	850	236.1	171		502.94			80	5.5		
4	550	152.8	264	1480	414.12	710	Y4502-4	75	3.5	φ 450	2350
	720	200	240		573.89			82	4.5		
	850	236.1	228		670.59			80	5.5		
5	550	152.8	330	1480	517.65	900	Y4504-4	75	3.5	φ 450	2650
	720	200	300		717.36			82	4.5		
	850	236.1	285		838.24			80	5.5		
6	550	152.8	396	1480	621.18	1120	Y5002-4	75	3.5	φ 450	2950
	720	200	360		860.83			82	4.5		
	850	236.1	342		1005.88			80	5.5		
7	550	152.8	462	1480	724.71	1250	Y5003-4	75	3.5	φ 450	3280
	720	200	420		1004.3			82	4.5		
	850	236.1	399		1173.53			80	5.5		
8	550	152.8	528	1480	828.24	1400	Y5004-4	75	3.5	φ 450	3595
	720	200	480		1147.78			82	4.5		
	850	236.1	456		1341.18			80	5.5		
9	550	152.8	594	1480	931.76	1600	Y5601-4	75	3.5	φ 450	3900
	720	200	540		1291.25			82	4.5		
	850	236.1	513		1508.82			80	5.5		

CMB 740-80 性能曲线

CMB 740-80 Performance Curve

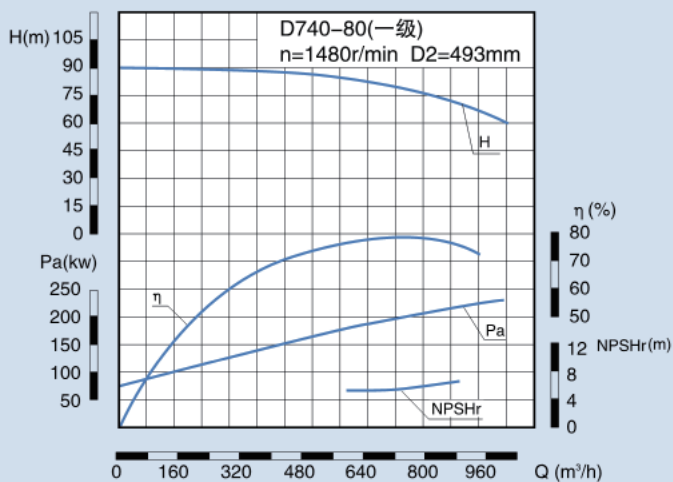

CMB 740-80 性能表

CMB 740-80 Performance Data

级数 Series	流量 Capacity		扬程 Head	转速 Speed	轴功率 Shaft power	配带电动机 Motor		效率 Eff.	必需汽 蚀余量 (NPSH)r	叶轮名 义直径 Impeller Dia.	泵重 Weight
	Q					功率 Power	型号 Type				
	m³/h	L/S	H	n	Pa			kW	η	m	mm
2	640	168.4	168.4	1480	378.5	500	Y4004-4	77.5	5.8	φ 493	2150
	740	160	160		411.2			78.4	6.2		
	840	146.6	146.6		433.6			77.3	6.5		
3	640	168.4	252.6	1480	567.9	710	Y4502-4	77.5	5.8	φ 493	2500
	740	160	240		616.8			78.4	6.2		
	840	146.6	219.9		650.4			77.3	6.5		
4	640	168.4	336.8	1480	757.2	1000	Y5001-4	77.5	5.8	φ 493	2850
	740	160	320		822.4			78.4	6.2		
	840	146.6	293.2		867.2			77.3	6.5		
5	640	168.4	421	1480	946.5	1250	Y5003-4	77.5	5.8	φ 493	3200
	740	160	400		1028			78.4	6.2		
	840	146.6	366.5		1084			77.3	6.5		
6	640	168.4	505.2	1480	1135.8	1600	Y5601-4	77.5	5.8	φ 493	3550
	740	160	480		1233.6			78.4	6.2		
	840	146.6	439.8		1300.8			77.3	6.5		

### CMB12 性能曲线

### CMB 12 Performance Curve

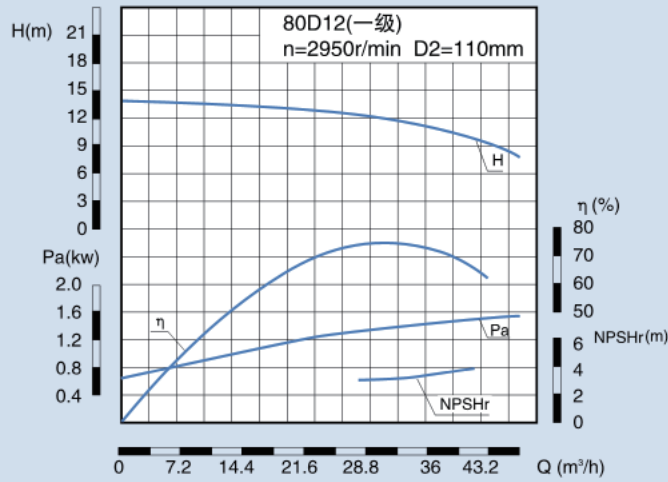

### CMB12 性能表

### CMB12 Performance Data

级数 Series	流量 Capacity		扬程 Head	转速 Speed	轴功率 Shaft power	配带电动机 Motor		效率 Eff.	必需汽 蚀余量 (NPSH)r	叶轮名 义直径 Impeller Dia.	泵重 Weight
	Q					功率 Power	型号 Type				
	m³/h	L/S	m	r/min	kW			kW	%	m	mm
2	21.6	6.0	28.8	2950	2.46	4	Y112M-2	69	3.2	φ 110	132
	34.6	9.6	22.8		2.84			75			
	39.6	11	19.0		2.82			72			
3	21.6	6.0	43.2	2950	3.69	5.5	Y132S <sub>1</sub> -2	69	3.2	φ 110	139
	34.6	9.6	34.2		4.26			75			
	39.6	11	28.5		4.23			72			
4	21.6	6.0	57.6	2950	4.92	7.5	Y132S <sub>2</sub> -2	69	3.2	φ 110	146
	34.6	9.6	45.6		5.69			75			
	39.6	11	38.0		5.64			72			
5	21.6	6.0	72.0	2950	6.15	11	Y160M <sub>1</sub> -2	69	3.2	φ 110	153
	34.6	9.6	57.0		7.10			75			
	39.6	11	47.5		7.05			72			
6	21.6	6.0	86.4	2950	7.38	11	Y160M <sub>1</sub> -2	69	3.2	φ 110	160
	34.6	9.6	68.4		8.52			75			
	39.6	11	57.0		8.46			72			
7	21.6	6.0	100.8	2950	8.61	15	Y160M <sub>2</sub> -2	69	3.2	φ 110	167
	34.6	9.6	79.8		9.94			75			
	39.6	11	66.5		9.87			72			
8	21.6	6.0	115.2	2950	9.84	15	Y160M <sub>2</sub> -2	69	3.2	φ 110	174
	34.6	9.6	91.2		11.36			75			
	39.6	11	76.0		11.28			72			
9	21.6	6.0	129.6	2950	11.07	18.5	Y160L-2	69	3.2	φ 110	181
	34.6	9.6	102.6		12.78			75			
	39.6	11	85.5		12.69			72			

CMB 16 性能曲线

CMB 16 Performance Curve

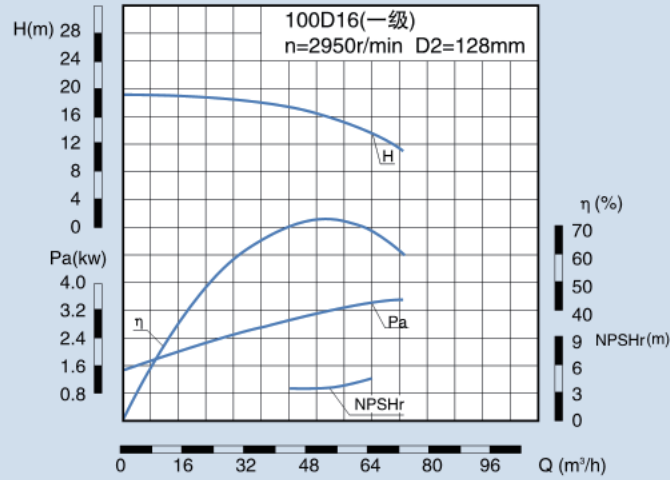

CMB 16 性能表

CMB 16 Performance Data

级数 Series	流量 Capacity		扬程 Head H	转速 Speed n	轴功率 Shaft power Pa	配带电动机 Motor		效率 Eff. η	必需汽 蚀余量 (NPSH)r	叶轮名 义直径 Impeller Dia. mm	泵重 Weight kg
	Q					功率 Power kW	型号 Type				
	m³/h	L/S	m	r/min	kW			Type	%	m	mm
2	36	10	40	2950	5.94	7.5	Y132S <sub>2</sub> -2	66	3.7	φ 128	165
	54	15	32		6.44			73			
	72	20	22		6.53			66			
3	36	10	60	2950	8.91	15	Y160M <sub>2</sub> -2	66	3.7	φ 128	177
	54	15	48		9.67			73			
	72	20	34		9.80			66			
4	36	10	80	2950	11.88	18.5	Y160L-2	66	3.7	φ 128	186
	54	15	64		12.89			73			
	72	20	45		13.07			66			
5	36	10	100	2950	14.85	22	Y180M-2	66	3.7	φ 128	195
	54	15	80		16.11			73			
	72	20	56		16.33			66			
6	36	10	120	2950	17.82	22	Y180M-2	66	3.7	φ 128	204
	54	15	96		19.33			73			
	72	20	67		19.60			66			
7	36	10	140	2950	20.79	30	Y200L <sub>1</sub> -2	66	3.7	φ 128	213
	54	15	112		22.55			73			
	72	20	78		22.87			66			
8	36	10	160	2950	23.76	30	Y200L <sub>1</sub> -2	66	3.7	φ 128	222
	54	15	128		25.78			73			
	72	20	90		26.13			66			
9	36	10	180	2950	26.73	37	Y200L <sub>2</sub> -2	66	3.7	φ 128	230
	54	15	144		29.00			73			
	72	20	101		29.40			66			

### CMB 25 性能曲线

### CMB25 Performance Curve

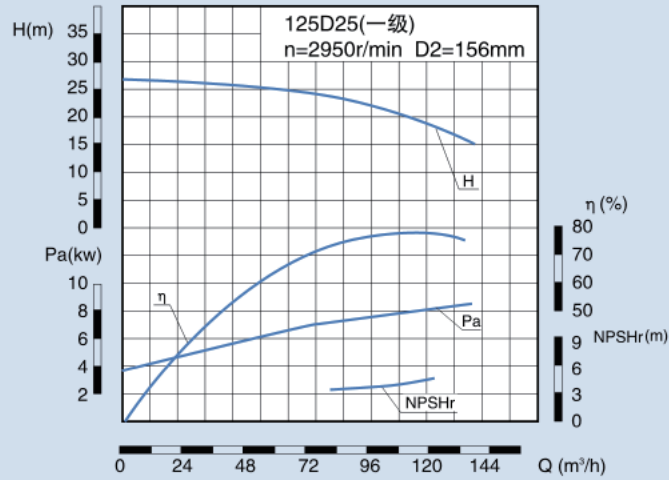

### CMB 25 性能表

### CMB 25 Performance Data

级数 Series	流量 Capacity		扬程 Head	转速 Speed	轴功率 Shaft power	配带电动机 Motor		效率 Eff.	必需汽 蚀余量 (NPSH) <sub>r</sub>	叶轮名 义直径 Impeller Dia.	泵重 Weight
	Q					功率 Power	型号 Type				
	m <sup>3</sup> /h	L/S	m	r/min	kW			kW	%	m	mm
2	72	20	51.2	2950	14.20	22	Y180M-2	70.5	3.2	φ 156	261
	101	28	43.0		15.20			77.5	3.6		
	119	33	35.0		15.30			77.0	4.3		
3	72	20	76.8	2950	21.30	30	Y200L <sub>1</sub> -2	70.5	3.2	φ 156	298
	101	28	64.5		22.80			77.5	3.6		
	119	33	52.5		22.90			77.0	4.3		
4	72	20	102.4	2950	28.40	37	Y200L <sub>2</sub> -2	70.5	3.2	φ 156	335
	101	28	86.0		30.40			77.5	3.6		
	119	33	70.0		30.60			77.0	4.3		
5	72	20	128.0	2950	35.50	45	Y225M-2	70.5	3.2	φ 156	372
	101	28	107.5		38.00			77.5	3.6		
	119	33	87.5		38.25			77.0	4.3		
6	72	20	153.6	2950	42.60	55	Y250M-2	70.5	3.2	φ 156	409
	101	28	129.0		45.60			77.5	3.6		
	119	33	105.0		45.90			77.0	4.3		
7	72	20	179.2	2950	49.70	75	Y280S-2	70.5	3.2	φ 156	446
	101	28	150.5		53.20			77.5	3.6		
	119	33	122.5		53.55			77.0	4.3		
8	72	20	204.8	2950	56.80	75	Y280S-2	70.5	3.2	φ 156	483
	101	28	172.0		60.80			77.5	3.6		
	119	33	140.0		61.20			77.0	4.3		
9	72	20	230.4	2950	63.90	90	Y280M-2	70.5	3.2	φ 156	520
	101	28	193.5		68.40			77.5	3.6		
	119	33	157.5		68.85			77.0	4.3		

CMB25-80次高压泵性能曲线表

CMB 25-80 Performance Curve

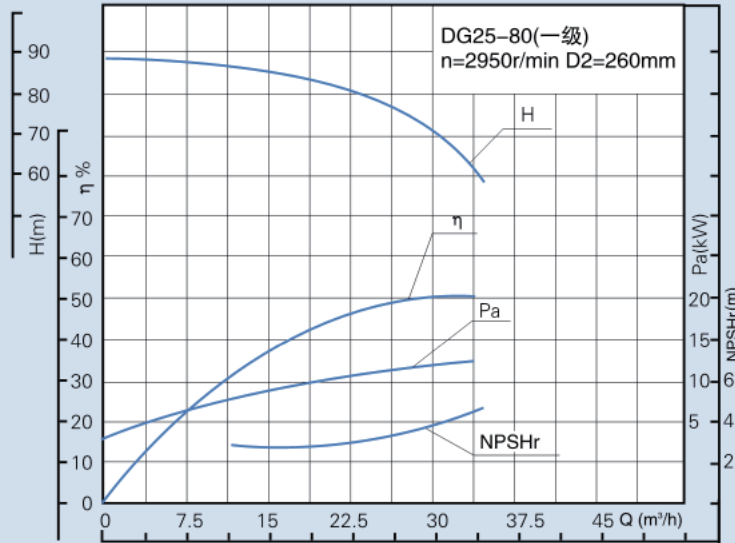

CMB25-80次高压泵性能表

CMB 25-80 Performance Data

级数 Series	流量 Capacity		扬程 Head H	转速 Speed n	轴功率 Shaft power Pa	配带电动机 Motor		效率 Eff. η	必需汽蚀余量 (NPSH)r	叶轮名义直径 Impeller Dia.	泵重 Weight
	Q					功率 Power	型号 Type				
	m³/h	L/S	m	r/min	kW			kW	%	m	mm
6	17.4	4.83	506	2950	57.91	90	Y280M-2	41.4	3.1	φ 260	832
	25	6.94	476		67.51			48	3.3		
	29.1	8.08	454		69.47			51.8	3.8		
7	17.4	4.83	590	2950	67.53	90	Y280M-2	41.4	3.1	φ 260	895
	25	6.94	556		78.86			48	3.3		
	29.1	8.08	530		81.1			51.8	3.8		
8	17.4	4.83	675	2950	77.25	110	Y315S-2	41.4	3.1	φ 260	958
	25	6.94	635		90.07			48	3.3		
	29.1	8.08	605		92.58			51.8	3.8		
9	17.4	4.83	760	2950	86.98	132	Y315M-2	41.4	3.1	φ 260	1021
	25	6.94	715		101.41			48	3.3		
	29.1	8.08	681		104.21			51.8	3.8		
10	17.4	4.83	844	2950	96.6	132	Y315M-2	41.4	3.1	φ 260	1084
	25	6.94	795		112.76			48	3.3		
	29.1	8.08	757		115.84			51.8	3.8		
11	17.4	4.83	928	2950	106.21	160	Y315L1-2	41.4	3.1	φ 260	1147
	25	6.94	875		124.11			48	3.3		
	29.1	8.08	833		127.47			51.8	3.8		
12	17.4	4.83	1013	2950	115.94	160	Y315L1-2	41.4	3.1	φ 260	1210
	25	6.94	954		135.31			48	3.3		
	29.1	8.08	908		138.94			51.8	3.8		

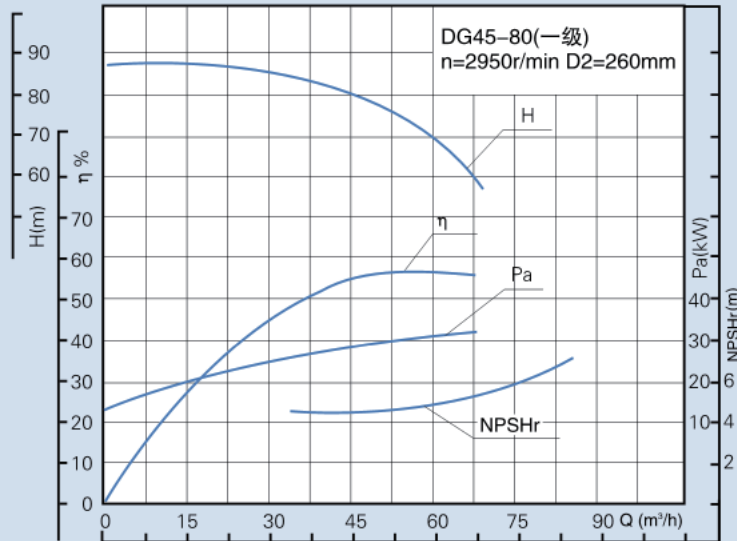
**CMB 45-80次高压泵性能曲线表**
**CMB 45-80 Performance Curve**

**CMB 45-80次高压泵性能表**
**CMB 45-80 Performance Data**

级数 Series	流量 Capacity		扬程 Head H	转速 Speed n	轴功率 Shaft power Pa	配带电动机 Motor		效率 Eff. η	必需汽 蚀余量 (NPSH)r	叶轮名 义直径 Impeller Dia.	泵重 Weight
	Q					功率 Power	型号 Type				
	m³/h	L/S	m	r/min	kW			kW	%	m	mm
6	36	10	502	2950	98.4	160	Y315L1-2	50	3.9	φ 260	915
	45	12.5	480		107			55	4.0		
	62	17.2	409		123.3			56	5.5		
7	36	11.0	585.6	2950	114.8	160	Y315L1-2	50	3.9	φ 260	983
	45	12.5	560		124.8			55	4.0		
	62	17.2	477.2		143.9			56	5.5		
8	36	10	669.2	2950	131.2	200	Y315L2-2	50	3.9	φ 260	1087
	45	12.5	640		142.6			55	4.0		
	62	17.2	545.4		164.4			56	5.5		
9	36	10	752.8	2950	147.6	220	Y355M1-2	50	3.9	φ 260	1155
	45	12.5	720		160.4			55	4.0		
	62	17.2	613.6		186			56	5.5		
10	36	10	836.4	2950	164	220	Y355M1-2	50	3.9	φ 260	1276
	45	12.5	800		178.3			55	4.0		
	62	17.2	681.8		205.3			56	5.5		
11	36	10	920	2950	180.4	250	Y355M2-2	50	3.9	φ 260	1344
	45	12.5	880		196.1			55	4.0		
	62	17.2	750		225.9			56	5.5		
12	36	10	1003.6	2950	196.8	280	Y355L1-2	50	3.9	φ 260	1413
	45	12.5	960		213.9			55	4.0		
	62	17.2	818.2		246.7			56	5.5		

CMB85-80次高压泵性能曲线表

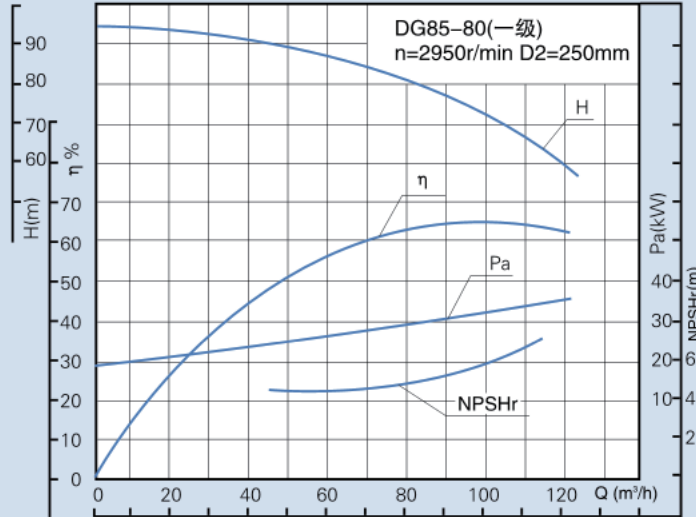
CMB 85-80 Performance Curve



CMB85-80次高压泵性能表

CMB85-80 Performance Data

级数 Series	流量 Capacity		扬程 Head	转速 Speed	轴功率 Shaft power	配带电动机 Motor		效率 Eff.	必需汽 蚀余量 (NPSH)r	叶轮名 义直径 Impeller Dia.	泵重 Weight
	Q					功率 Power	型号 Type				
	m³/h	L/S	m	r/min	kW			kW	%	m	mm
7	54	15	616	2950	170.9	250	Y355M <sub>2</sub> -2	53	3.5	φ 250	1567
	85	23	560		199.3			65			
	108	30.0	490		218.4			66			
8	54	15	704	2950	195.3	280	Y355L <sub>1</sub> -2	53	3.5	φ 250	1640
	85	23	640		227.8			65			
	108	30.0	560		249.6			66			
9	54	15	792	2950	219.8	355	Y3555-2	53	3.5	φ 250	1713
	85	23	720		256.3			65			
	108	30.0	630		280.7			66			
10	54	15	880	2950	244.2	355	Y3555-2	53	3.5	φ 250	1786
	85	23	800		284.8			65			
	108	30.0	700		311.9			66			
11	54	15	968	2950	268.6	400	Y3556-2	53	3.5	φ 250	1859
	85	23	880		313.2			65			
	108	30.0	770		343			66			
12	54	15	1056	2950	293	450	Y4001-1	53	3.5	φ 250	1932
	85	23	960		341.7			65			
	108	30.0	840		374.3			66			

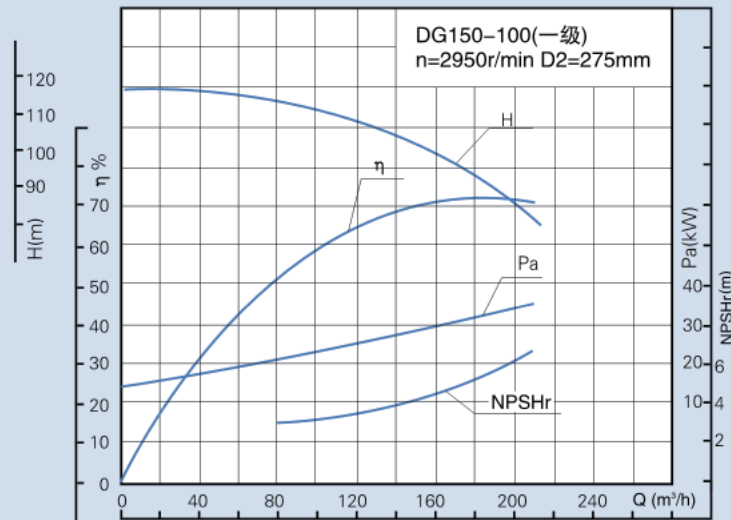
**CMB150-100次高压泵性能曲线表**
**CMB150-100 Performance Curve**

**CMB150-100次高压泵性能表**
**CMB150-100 Performance Data**

级数 Series	流量 Capacity		扬程 Head	转速 Speed	轴功率 Shaft power	配带电动机 Motor		效率 Eff.	必需汽 蚀余量 (NPSH)r	叶轮名 义直径 Impeller Dia.	泵重 Weight
	Q					功率 Power	型号 Type				
	m³/h	L/S	m	r/min	kW			kW	%	m	mm
6	120	33.3	630	2950	307	400	Y3556-2	67	3.4	φ 275	2735
	150	41.7	591		345			70	4.8		
	180	50	540		368			72	5.5		
7	120	33.3	735	2950	359	450	Y4001-2	67	3.4	φ 275	2885
	150	41.7	689.5		403			70	4.8		
	180	50	630		429			72	5.5		
8	120	33.3	840	2950	410	560	Y4003-2	67	3.4	φ 275	3035
	150	41.7	788		460			70	4.8		
	180	50	720		491			72	5.5		
9	120	33.3	945	2950	461	630	Y4004-2	67	3.4	φ 275	3185
	150	41.7	886.1		518			70	4.8		
	180	50	810		552			72	5.5		
10	120	33.3	1050	2950	512	710	Y4501-2	67	3.4	φ 275	3335
	150	41.7	985		575			70	4.8		
	180	50	900		613			72	5.5		

## 外形安装图 Overall and Installation Figure

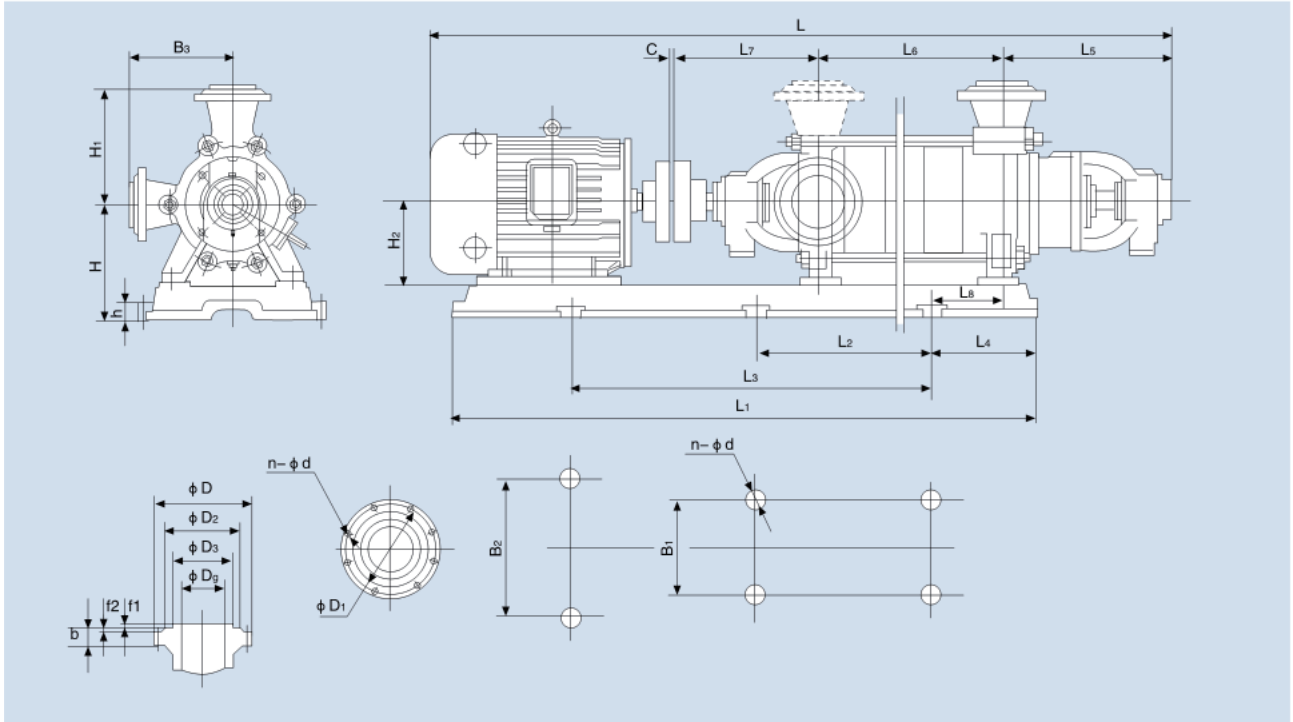
CMB 型泵外形安装图(公用底座) (With Common Base)



CMB 型泵外形安装图(本身底座) (With Pump Base)

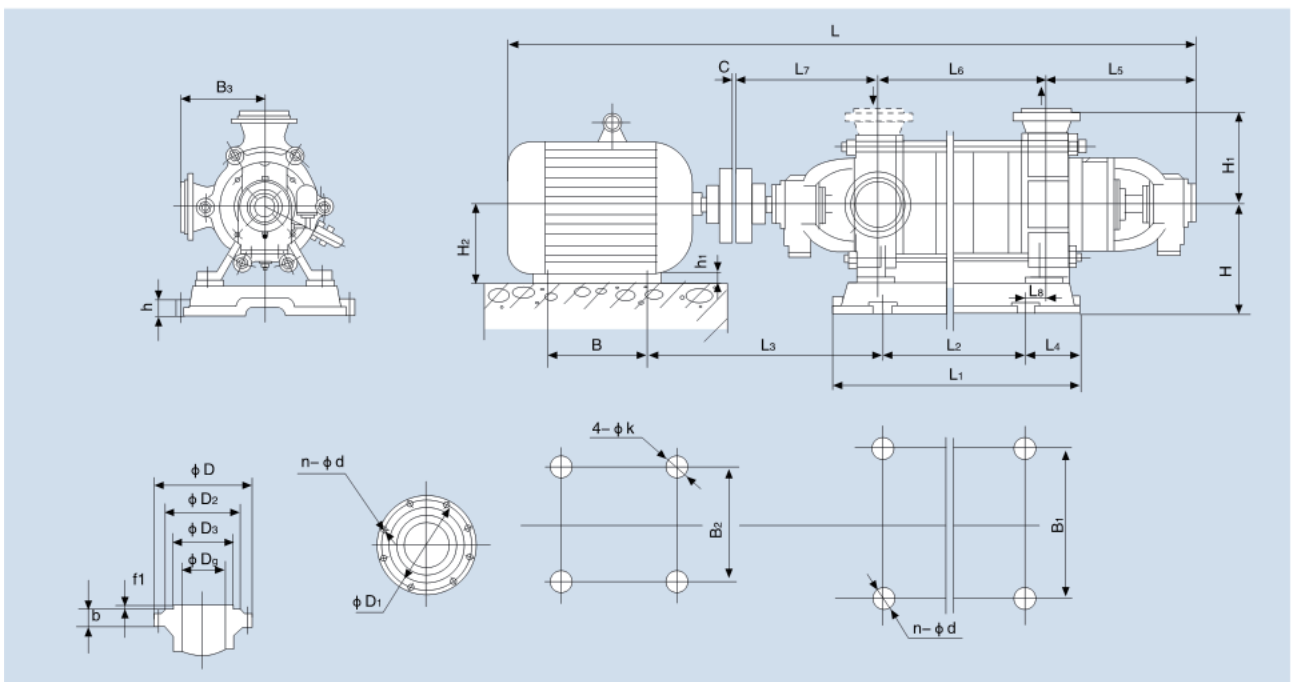

**CMB6-25 外型安装尺寸表**
**CMB6-25 Installation Dimensions**

(公用底座) (With Common Base)

级数	L	L <sub>1</sub>	L <sub>2</sub>	L <sub>3</sub>	L <sub>4</sub>	L <sub>5</sub>	L <sub>6</sub>	L <sub>7</sub>	L <sub>8</sub>	C	B <sub>1</sub>	B <sub>2</sub>	B <sub>3</sub>	H	H <sub>1</sub>	H <sub>2</sub>	h	n-φd
2	1047	855	/	575	145	240	130	275	85	2	350	350	170	275	170	100	30	4-φ24
3	1192	965	/	645	190	240	180	275	55	2	370	370	170	275	170	132	30	4-φ24
4	1242	965	/	645	190	240	230	275	105	2	370	370	170	275	170	132	30	4-φ24
5	1292	965	/	645	190	240	280	275	155	2	370	370	170	275	170	132	30	4-φ24
6	1478	1215	/	820	230	240	330	275	105	2	360	430	170	260	170	160	30	4-φ24
7	1528	1215	/	820	230	240	380	275	155	2	360	430	170	260	170	160	30	4-φ24
8	1578	1430	/	920	300	240	430	275	170	2	410	480	170	270	170	160	35	4-φ24
9	1628	1430	/	920	300	240	480	275	170	2	410	480	170	270	170	160	35	4-φ24
10	1723	1500	/	990	350	240	530	275	170	2	365	460	170	280	170	160	40	4-φ24
11	1773	1500	/	990	350	240	580	275	220	2	365	460	170	280	170	160	40	4-φ24
12	1823	1500	/	990	350	240	630	275	270	2	365	460	170	280	170	160	40	4-φ24

**CMB 外型安装尺寸表**
**CMB6-50 Installation Dimensions**

(公用底座) (With Common Base)

级数	L	L <sub>1</sub>	L <sub>2</sub>	L <sub>3</sub>	L <sub>4</sub>	L <sub>5</sub>	L <sub>6</sub>	L <sub>7</sub>	L <sub>8</sub>	C	B <sub>1</sub>	B <sub>2</sub>	B <sub>3</sub>	H	H <sub>1</sub>	H <sub>2</sub>	h	n-φd
2	1407	1170	/	840	190	284	160	343	5	2	480	480	215	260	215	160	35	4-φ24
3	1467	1170	/	840	190	284	220	343	70	2	480	480	215	260	215	160	35	4-φ24
4	1572	1230	/	845	210	284	280	343	140	2	460	460	215	260	215	160	35	4-φ24
5	1654	1310	/	880	240	284	340	343	190	2	465	465	215	260	215	180	35	4-φ24
6	1822	1650	/	990	415	284	400	343	155	2	445	510	215	280	215	200	35	4-φ24
7	1882	1650	/	990	415	284	460	343	215	2	445	510	215	280	215	200	35	4-φ24
8	1942	1650	/	990	415	284	520	343	275	2	445	510	215	280	215	200	35	4-φ24
9	2002	1650	/	990	415	284	580	343	335	2	445	510	215	280	215	200	35	4-φ24
10	2097	1750	/	1305	220	284	640	343	155	2	470	545	215	305	215	225	35	4-φ24
11	2157	1750	/	1305	220	284	700	343	215	2	470	545	215	305	215	225	35	4-φ24
12	2335	2000	600	1200	400	284	760	343	329	2	460	595	215	330	215	250	35	4-φ24

**CMB12-25 外型安装尺寸表**
**CMB12-25 Installation Dimensions**

(公用底座) (With Common Base)

级数	L	L <sub>1</sub>	L <sub>2</sub>	L <sub>3</sub>	L <sub>4</sub>	L <sub>5</sub>	L <sub>6</sub>	L <sub>7</sub>	L <sub>8</sub>	C	B <sub>1</sub>	B <sub>2</sub>	B <sub>3</sub>	H	H <sub>1</sub>	H <sub>2</sub>	h	n-φd
2	1067	965	/	645	190	240	130	275	-5	2	370	370	170	250	170	132	30	4-φ24
3	1192	965	/	645	190	240	180	275	55	2	370	370	170	250	170	132	30	4-φ24
4	1378	1120	/	745	205	240	230	275	75	2	360	440	170	255	170	160	35	4-φ24
5	1428	1120	/	745	205	240	280	275	125	2	360	440	170	255	170	160	35	4-φ24
6	1478	1215	/	820	230	240	330	275	105	2	360	430	170	255	170	160	30	4-φ24
7	1528	1215	/	820	230	240	380	275	155	2	360	430	170	255	170	160	30	4-φ24
8	1623	1430	/	920	300	240	430	275	170	2	410	480	170	270	170	160	35	4-φ24
9	1673	1430	/	920	300	240	480	275	170	2	410	480	170	270	170	160	35	4-φ24
10	1743	1490	/	975	355	240	530	275	185	2	365	470	170	280	170	180	30	4-φ24
11	1793	1490	/	975	355	240	580	275	235	2	365	470	170	280	170	180	30	4-φ24
12	1952	1640	/	965	445	240	630	275	365	2	350	500	170	350	170	200	45	4-φ24

CMB12-50 外型安装尺寸表

CMB12-50 Installation Dimensions

(公用底座) (With Common Base)

级数	L	L <sub>1</sub>	L <sub>2</sub>	L <sub>3</sub>	L <sub>4</sub>	L <sub>5</sub>	L <sub>6</sub>	L <sub>7</sub>	L <sub>8</sub>	C	B <sub>1</sub>	B <sub>2</sub>	B <sub>3</sub>	H	H <sub>1</sub>	H <sub>2</sub>	h	n-φd
2	1412	1230	/	845	210	284	160	345	15	5	460	460	215	260	215	160	30	4-φ24
3	1517	1230	/	845	210	284	220	345	75	5	460	460	215	260	215	160	30	4-φ24
4	1597	1310	/	880	240	284	280	345	130	5	465	465	215	260	215	180	30	4-φ24
5	1762	1650	/	990	415	284	340	345	120	5	445	510	215	280	215	180	35	4-φ24
6	1822	1650	/	990	415	284	400	345	185	5	445	510	215	280	215	200	35	4-φ24
7	1882	1650	/	990	415	284	460	345	245	5	445	510	215	280	215	200	35	4-φ24
8	1982	1750	/	1305	220	284	520	345	-5	5	470	545	215	215	215	225	35	4-φ24
9	2042	1750	/	1305	220	284	580	345	55	5	470	545	215	215	215	225	35	4-φ24
10	2204	1870	500	1200	420	284	640	345	288	5	460	595	215	330	215	250	35	6-φ30
11	2264	1870	500	1200	420	284	700	345	348	5	460	595	215	330	215	250	35	6-φ30
12	2407	2000	600	1300	400	284	760	345	329	5	460	645	215	360	215	280	35	6-φ30

CMB25-30 外型安装尺寸表

CMB25-30 Installation Dimensions

(公用底座) (With Common Base)

级数	L	L <sub>1</sub>	L <sub>2</sub>	L <sub>3</sub>	L <sub>4</sub>	L <sub>5</sub>	L <sub>6</sub>	L <sub>7</sub>	L <sub>8</sub>	C	B <sub>1</sub>	B <sub>2</sub>	B <sub>3</sub>	H	H <sub>1</sub>	H <sub>2</sub>	h	n-φd
2	1416	1170	/	840	190	285	165	345	5	5	480	480	210	260	210	160	35	4-φ24
3	1481	1170	/	840	190	285	230	345	70	5	480	480	210	260	210	160	35	4-φ24
4	1591	1230	/	845	210	285	295	345	140	5	460	460	210	260	210	160	35	4-φ24
5	1680	1310	/	880	240	285	360	345	190	5	465	465	210	260	210	180	30	4-φ24
6	1850	1440	/	990	415	285	425	345	155	5	465	510	210	280	210	200	35	4-φ24
7	1915	1650	/	990	415	285	490	345	215	5	445	510	210	280	210	200	35	4-φ24
8	1980	1650	/	990	415	285	555	345	275	5	445	510	210	280	210	200	35	4-φ24
9	2045	1650	/	990	415	285	620	345	335	5	445	510	210	280	210	200	35	4-φ24
10	2150	1750	/	1305	220	285	685	345	155	5	470	545	210	315	210	225	35	4-φ24

CMB25-50 外型安装尺寸表

CMB25-50 Installation Dimensions

(公用底座) (With Common Base)

级数	L	L <sub>1</sub>	L <sub>2</sub>	L <sub>3</sub>	L <sub>4</sub>	L <sub>5</sub>	L <sub>6</sub>	L <sub>7</sub>	L <sub>8</sub>	C	B <sub>1</sub>	B <sub>2</sub>	B <sub>3</sub>	H	H <sub>1</sub>	H <sub>2</sub>	h	n-φd
3	1637	1240	/	665	280	355	250	345	175	2	500	500	300	360	270	180	40	4-φ24
4	1802	1430	/	900	250	355	310	345	100	2	520	520	300	320	270	200	45	4-φ24
5	1862	1430	/	900	250	355	370	345	160	2	520	520	300	320	270	200	45	4-φ24
6	1962	1560	530	1060	235	355	430	345	165	2	560	560	300	365	270	225	40	6-φ24
7	2137	1740	555	1120	360	355	490	345	125	2	530	600	300	350	270	250	40	6-φ24
8	2267	2040	725	1470	380	355	550	345	120	2	500	720	300	430	270	280	40	6-φ24
9	2327	2040	725	1470	380	355	610	345	110	2	500	720	300	430	270	280	40	6-φ24
10	2387	2040	725	1470	380	355	670	345	170	2	500	720	300	430	270	280	40	6-φ24
11	2497	2040	725	1470	380	355	730	345	230	2	500	720	300	430	270	280	40	6-φ24
12	2753	2200	745	1490	370	355	790	345	270	2	510	730	300	440	270	315	50	6-φ24

**CMB 46-30 外型安装尺寸表**
**CMB 46-30 Installation Dimensions**

(公用底座) (With Common Base)

级数	L	L <sub>1</sub>	L <sub>2</sub>	L <sub>3</sub>	L <sub>4</sub>	L <sub>5</sub>	L <sub>6</sub>	L <sub>7</sub>	L <sub>8</sub>	C	B <sub>1</sub>	B <sub>2</sub>	B <sub>3</sub>	H	H <sub>1</sub>	H <sub>2</sub>	h	n-φd
2	1416	1170	/	840	190	280	165	345	5	5	485	485	210	260	210	160	40	4-φ24
3	1546	1170	/	840	140	280	230	345	130	5	465	485	210	260	210	180	40	4-φ24
4	1720	1440	/	930	310	280	295	345	140	5	465	510	210	280	210	200	30	4-φ24
5	1785	1400	/	930	310	280	360	345	190	5	465	510	210	280	210	200	30	4-φ24
6	1855	1440	/	930	310	280	425	345	210	5	465	510	210	280	210	200	30	4-φ24
7	1955	1560	/	110	230	280	490	345	150	5	460	540	210	315	210	225	35	4-φ24
8	2135	1750	/	1120	390	280	555	345	260	5	480	610	210	330	210	250	30	4-φ24
9	2200	1750	/	1120	390	280	620	345	325	5	480	610	210	330	210	250	30	4-φ24
10	2335	1910	/	1240	410	280	685	345	340	5	470	660	210	360	210	280	30	4-φ24

**CMB 46-50 外型安装尺寸表**
**CMB 46-50 Installation Dimensions**

(公用底座) (With Common Base)

级数	L	L <sub>1</sub>	L <sub>2</sub>	L <sub>3</sub>	L <sub>4</sub>	L <sub>5</sub>	L <sub>6</sub>	L <sub>7</sub>	L <sub>8</sub>	C	B <sub>1</sub>	B <sub>2</sub>	B <sub>3</sub>	H	H <sub>1</sub>	H <sub>2</sub>	h	n-φd
2	1682	1430	/	900	250	355	190	345	-15	2	520	520	300	320	270	200	45	4-φ24
3	1742	1430	/	900	250	355	250	345	45	2	520	520	300	320	270	200	45	4-φ24
4	1842	1560	530	1060	235	355	310	345	0	2	560	560	300	365	270	225	40	6-φ24
5	2017	1740	555	1115	360	355	370	345	100	2	530	600	300	350	270	250	40	6-φ24
6	2147	2040	725	1470	380	355	430	345	-30	2	500	720	300	430	270	280	40	6-φ24
7	2257	2040	725	1470	380	355	490	345	60	2	500	720	300	430	270	280	40	6-φ24
8	2317	2040	725	1470	380	355	550	345	120	2	500	720	300	430	270	280	40	6-φ24
9	2573	2200	745	1490	370	355	610	345	110	2	510	730	300	440	270	315	50	6-φ24
10	2703	2200	745	1490	370	355	670	345	170	2	510	730	300	440	270	315	50	6-φ24
11	2763	2200	745	1490	370	355	730	345	230	2	510	730	300	440	270	315	50	6-φ24
12	2823	2200	745	1490	370	355	790	345	270	2	510	730	300	440	270	315	50	6-φ24

**CMB 80-30 外型安装尺寸表**
**CMB 80-30 Installation Dimensions**

(公用底座) (With Common Base)

级数	L	L <sub>1</sub>	L <sub>2</sub>	L <sub>3</sub>	L <sub>4</sub>	L <sub>5</sub>	L <sub>6</sub>	L <sub>7</sub>	L <sub>8</sub>	C	B <sub>1</sub>	B <sub>2</sub>	B <sub>3</sub>	H	H <sub>1</sub>	H <sub>2</sub>	h	n-φd
3	1449	1140	/	785	200	245	229	300	120	2	440	440	200	280	205	160	30	4-φ24
4	1530	1200	/	785	215	245	290	300	140	2	440	440	200	275	205	180	30	4-φ24
5	1698	1415	/	1010	195	245	351	300	50	2	430	490	200	300	205	200	40	4-φ24
6	1759	1415	/	1010	195	245	412	300	110	2	430	490	200	300	205	200	40	4-φ24
7	1860	1520	/	995	265	245	473	300	165	2	440	540	200	335	205	225	45	4-φ24
8	2036	1820	665	1330	240	245	534	300	60	2	455	600	200	350	205	250	40	6-φ24
9	2097	1820	665	1330	240	245	595	300	90	2	455	600	200	350	205	250	40	6-φ24
10	2158	1820	665	1330	240	245	656	300	150	2	455	600	200	350	205	250	40	6-φ24

CMB85-45 外型安装尺寸表  
CMB45 外型安装尺寸表

CMB 85-45 Installation Dimensions  
CMB 45 Installation Dimensions

(公用底座) (With Common Base)

级数	L	L <sub>1</sub>	L <sub>2</sub>	L <sub>3</sub>	L <sub>4</sub>	L <sub>5</sub>	L <sub>6</sub>	L <sub>7</sub>	L <sub>8</sub>	C	B <sub>1</sub>	B <sub>2</sub>	B <sub>3</sub>	H	H <sub>1</sub>	H <sub>2</sub>	h	n-φd
2	1641	1250	/	840	200	304	203	340	110	4	520	520	250	325	250	200	30	4-φ24
3	1870	1520	/	1040	230	304	277	340	130	4	530	635	250	360	250	250	40	4-φ24
4	2014	1690	560	1120	310	304	351	340	145	4	520	670	250	385	250	280	35	6-φ24
5	2137	1690	560	1120	310	304	425	340	205	4	520	670	250	385	250	280	35	6-φ24

CMB 85-45 外型安装尺寸表  
CMB 45 外型安装尺寸表

CMB 85-45 Installation Dimensions  
CMB 45 Installation Dimensions

(本身底座) (With Pump Base)

级数	L	L <sub>1</sub>	L <sub>2</sub>	L <sub>3</sub>	L <sub>4</sub>	L <sub>5</sub>	L <sub>6</sub>	L <sub>7</sub>	L <sub>8</sub>	C	B	B <sub>1</sub>	B <sub>2</sub>	B <sub>3</sub>	H	H <sub>1</sub>	H <sub>2</sub>	h	n-φd	4-φK
4	2014	600	330	707	135	304	351	340	3	4	368	520	460	250	345	250	280	40	4-φ24	φ24
5	2137	750	380	694	190	304	425	340	40	4	419	540	535	250	345	250	280	40	4-φ24	φ24
6	2408	750	380	785	190	304	499	340	53	4	406	540	535	250	345	250	315	40	4-φ24	φ28
7	2552	750	380	821	190	304	573	340	90	4	457	540	535	250	345	250	315	40	4-φ24	φ28
8	2626	900	525	779	190	304	647	340	61	4	457	520	510	250	345	250	315	40	4-φ26	φ28
9	2700	900	525	816	190	304	721	340	98	4	457	520	510	250	345	250	315	40	4-φ26	φ28

CMB85-67 外型安装尺寸表

CMB 85-67 Installation Dimensions

(本身底座) (With Pump Base)

级数	L	L <sub>1</sub>	L <sub>2</sub>	L <sub>3</sub>	L <sub>4</sub>	L <sub>5</sub>	L <sub>6</sub>	L <sub>7</sub>	L <sub>8</sub>	C	B	B <sub>1</sub>	B <sub>2</sub>	B <sub>3</sub>	H	H <sub>1</sub>	H <sub>2</sub>	h	n-φd	4-φK
3	2465	765	400	880.5	182	479	371	559	-14	4	419	600	457	350	420	350	280	50	4-φ30	φ24
4	2743	765	400	950.5	182	479	459	559	29.5	4	406	600	508	350	420	350	315	60	4-φ30	φ28
5	2901	765	400	994.5	182	479	547	559	73.5	4	457	600	508	350	420	350	315	60	4-φ30	φ28
6	2989	945	580	948.5	182	479	635	559	27.5	4	457	600	508	350	420	350	315	50	4-φ30	φ28
7	3007	945	580	992.5	182	479	723	559	71.5	4	457	600	508	350	420	350	315	50	4-φ30	φ28
8	3395	1125	760	946.5	182	479	811	559	25.5	4	560	600	610	350	420	350	355	60	4-φ30	φ28
9	3483	1125	760	990.5	182	479	899	559	69.5	4	560	600	610	350	420	350	355	60	4-φ30	φ28

**CMB120-50 外型安装尺寸表**
**CMB120-50 Installation Dimensions**

(公用底座) (With Common Base)

级数	L	L <sub>1</sub>	L <sub>2</sub>	L <sub>3</sub>	L <sub>4</sub>	L <sub>5</sub>	L <sub>6</sub>	L <sub>7</sub>	L <sub>8</sub>	C	B <sub>1</sub>	B <sub>2</sub>	B <sub>3</sub>	H	H <sub>1</sub>	H <sub>2</sub>	h	n-φd
2	1912	1430	/	900	265	304	260.5	353.5	202	4	595	595	300	355	1316	250	50	4-φ28
3	2119	1635	/	1000	300	304	347.5	353.5	237	4	545	650	300	385	1316	280	50	4-φ28
4	2466	1895	500	1200	300	304	434.5	353.5	237	4	550	735	300	435	1316	345	50	6-φ40
5	2253	1895	500	1200	300	304	521.5	353.5	237	4	550	735	300	435	1316	315	50	6-φ40
6	2640	2210	550	1350	400	304	608.5	353.5	337	4	550	750	300	435	1316	315	50	6-φ40
7	2727	2210	550	1350	400	304	695.5	353.5	337	4	550	750	300	435	1316	315	50	6-φ40
8	2814	2210	550	1350	400	304	782.5	353.5	337	4	550	750	300	435	1316	315	50	6-φ40
9	2901	2370	800	1600	400	304	869.5	353.5	337	4	550	860	300	485	1316	355	50	6-φ40

**CMB 155-30 外型安装尺寸表**
**CMB 155-30 Installation Dimensions**
**CMB 150-30 外型安装尺寸表**
**CMB 150-30 Installation Dimensions**

(公用底座) (With Common Base)

级数	L	L <sub>1</sub>	L <sub>2</sub>	L <sub>3</sub>	L <sub>4</sub>	L <sub>5</sub>	L <sub>6</sub>	L <sub>7</sub>	L <sub>8</sub>	C	B <sub>1</sub>	B <sub>2</sub>	B <sub>3</sub>	H	H <sub>1</sub>	H <sub>2</sub>	h	n-φd
2	1916	1980	680	1350	315	365	310	388	-25	4	660	660	350	400	350	225	35	6-φ26
3	2186	1980	680	1350	315	365	425	388	90	4	660	660	350	400	350	280	35	6-φ26
4	2351	1980	680	1350	315	365	540	388	210	4	660	660	350	400	350	280	35	6-φ26
5	2710	2400	750	1500	530	365	655	418	230	4	580	720	350	445	350	315	35	6-φ26
6	2897	2400	750	1500	530	365	770	418	345	4	580	720	350	445	350	315	35	6-φ26
7	3014	2400	750	1500	530	365	885	418	460	4	580	720	350	445	350	315	35	6-φ26

**CMB 155-30 外型安装尺寸表**
**CMB 155-30 Installation Dimensions**
**CMB 150-30 外型安装尺寸表**
**CMB 150-30 Installation Dimensions**

(本身底座) (With Pump Base)

级数	L	L <sub>1</sub>	L <sub>2</sub>	L <sub>3</sub>	L <sub>4</sub>	L <sub>5</sub>	L <sub>6</sub>	L <sub>7</sub>	L <sub>8</sub>	C	B	B <sub>1</sub>	B <sub>2</sub>	B <sub>3</sub>	H	H <sub>1</sub>	H <sub>2</sub>	h	n-φd	4-φK
2	1916	740	450	605	140	365	310	388	-70	4	311	600	356	350	400	350	225	50	4-φ30	φ24
3	2186	740	450	746	140	365	425	388	-12.5	4	368	600	457	350	400	350	280	50	4-φ30	φ24
4	2351	740	450	804	140	365	540	388	45	4	419	600	457	350	400	350	280	50	4-φ30	φ24
5	2710	1060	805	811	140	365	655	418	70	4	406	580	508	350	400	350	315	40	4-φ30	φ28
6	2897	1060	805	868	140	365	770	418	12.5	4	457	580	508	350	400	350	315	40	4-φ30	φ28
7	3014	1060	805	958	140	365	885	418	-45	4	457	580	508	350	400	350	315	40	4-φ30	φ28
8	3130	1500	1210	821	145	365	1000	418	-105	4	508	595	508	350	400	350	315	40	4-φ25	φ28
9	3245	1500	1210	878	145	365	1115	418	-47.5	4	508	595	508	350	400	350	315	40	4-φ25	φ28
10	3590	1500	1210	903	145	365	1230	418	10	4	560	595	610	350	400	350	355	40	4-φ25	φ28

CMB155-67 外型安装尺寸表

CMB155-67 Installation Dimensions

(本身底座) (With Pump Base)

级数	L	L <sub>1</sub>	L <sub>2</sub>	L <sub>3</sub>	L <sub>4</sub>	L <sub>5</sub>	L <sub>6</sub>	L <sub>7</sub>	L <sub>8</sub>	C	B	B <sub>1</sub>	B <sub>2</sub>	B <sub>3</sub>	H	H <sub>1</sub>	H <sub>2</sub>	h	n-φd	4-φK
3	2725	765	400	906.5	182	479	371	559	-14	4	457	600	508	350	420	350	315	50	4-φ30	φ28
4	2743	765	400	950.5	182	479	45	559	29.5	4	457	600	508	350	420	350	315	50	4-φ30	φ28
5	3131	765	400	995.5	182	479	547	559	73.5	4	560	600	610	350	420	350	355	50	4-φ30	φ28
6	3219	945	580	987.5	182	479	635	559	27.5	4	630	600	610	350	420	350	355	50	4-φ30	φ28
7	3308	945	580	1031	182	479	723	559	71.5	5	630	600	610	350	420	350	355	50	4-φ30	φ28
8	3295	1125	760	985.5	182	479	811	559	25.5	5	630	600	610	350	420	350	355	50	4-φ30	φ28
9	4634	1125	760	1095	182	479	899	559	69.5	5	1000	600	710	350	420	350	400	50	4-φ30	φ32

CMB280-43(200 43) 外型安装尺寸表

CMB280-43(200 43) Installation Dimensions

(本身底座) (With Pump Base)

级数	L	L <sub>1</sub>	L <sub>2</sub>	L <sub>3</sub>	L <sub>4</sub>	L <sub>5</sub>	L <sub>6</sub>	L <sub>7</sub>	L <sub>8</sub>	C	B	B <sub>1</sub>	B <sub>2</sub>	B <sub>3</sub>	H	H <sub>1</sub>	H <sub>2</sub>	h	h <sub>1</sub>	n-φd	4-φK
2	2423	735	435	773	150	384	373	388	-52	5	406	700	508	450	480	400	315	50	35	4-φ30	φ28
3	2623	735	435	838	150	384	503	388	13	5	457	700	508	450	480	400	315	50	35	4-φ30	φ28
4	2753	735	435	903	150	384	633	388	78	5	508	700	508	450	480	400	315	50	38	4-φ30	φ28
5	3113	1125	800	821.5	162.5	384	763	388	-39.5	5	560	700	610	450	480	400	355	50	38	4-φ30	φ28
6	3243	1125	800	886.5	162.5	384	893	388	25.5	5	630	700	610	450	480	400	355	50	38	4-φ30	φ28
7	3815	1125	800	1072.5	162.5	384	1023	420	90.5	6	1000	700	710	450	480	400	400	50	38	4-φ30	φ35
8	3945	1385	1060	1007.5	162.5	384	1153	420	25.5	6	1000	700	710	450	480	400	400	50	38	4-φ30	φ35
9	4075	1385	1060	1072.5	162.5	384	1283	420	90.5	6	1000	700	710	450	480	400	400	50	38	4-φ30	φ35

CMB280-65(200 65) 外型安装尺寸表

CMB280-65(200 65) Installation Dimensions

(本身底座) (With Pump Base)

级数	L	L <sub>1</sub>	L <sub>2</sub>	L <sub>3</sub>	L <sub>4</sub>	L <sub>5</sub>	L <sub>6</sub>	L <sub>7</sub>	L <sub>8</sub>	C	B	B <sub>1</sub>	B <sub>2</sub>	B <sub>3</sub>	H	H <sub>1</sub>	H <sub>2</sub>	h	h <sub>1</sub>	n-φd	4-φK
3	3214	690	310	1243	190	536	475	625	80	6	900	790	630	500	530	500	355	50	35	4-φ40	φ28
4	3754	820	440	1263	190	536	605	625	80	6	1000	790	710	500	530	500	400	50	38	4-φ40	φ35
5	3884	950	570	1263	190	536	735	625	80	6	1000	790	710	500	530	500	400	50	38	4-φ40	φ35
6	4014	1080	700	1284	190	536	865	625	80	7	1000	790	710	500	530	500	400	50	38	4-φ40	φ35
7	4345	1210	830	1284	190	536	995	625	80	7	1120	790	800	500	530	500	450	50	38	4-φ40	φ35
8	4475	1340	960	1284	190	536	1125	625	80	7	1120	790	800	500	530	500	450	50	38	4-φ40	φ35
9	4605	1470	1090	1284	190	536	1255	625	80	7	1120	790	800	500	530	500	450	50	38	4-φ40	φ35
10	5105	1600	1220	1444	190	536	1385	625	80	7	1120	790	800	500	530	500	450	50	38	4-φ40	φ35

**CMB360-40 外型安装尺寸表**
**CMB360-40 Installation Dimensions**

(本身底座) (With Pump Base)

级数	L	L <sub>1</sub>	L <sub>2</sub>	L <sub>3</sub>	L <sub>4</sub>	L <sub>5</sub>	L <sub>6</sub>	L <sub>7</sub>	L <sub>8</sub>	C	B	B <sub>1</sub>	B <sub>2</sub>	B <sub>3</sub>	H	H <sub>1</sub>	H <sub>2</sub>	h	h <sub>1</sub>	n-φd	4-φK
2	2539	505	200	927	150	384	390	417	73	6	457	700	508	450	450	400	315	50	38	4-φ40	φ28
3	2909	645	340	965	150	384	530	417	73	6	560	700	610	450	450	400	355	50	38	4-φ40	φ28
4	3049	785	480	965	150	384	670	417	73	6	560	700	610	450	450	400	355	50	38	4-φ40	φ28
5	3189	925	620	965	150	384	810	417	73	6	630	700	610	450	450	400	355	50	40	4-φ40	φ28
6	3731	1065	760	1087	150	384	950	417	73	6	1000	700	710	450	450	400	400	50	40	4-φ40	φ35
7	3871	1205	900	1087	150	384	1090	417	73	6	1000	700	710	450	450	400	400	50	40	4-φ40	φ35
8	4011	1345	1040	1087	150	384	1230	417	73	6	1000	700	710	450	450	400	400	50	40	4-φ40	φ35
9	4151	1485	1180	1087	150	384	1370	417	73	6	100	700	710	450	450	400	400	50	40	4-φ40	φ35
10	4291	1626	1320	1107	150	384	1510	417	73	6	1120	700	800	450	450	400	450	50	40	4-φ40	φ35

**CMB 450-60(250 60) 外型安装尺寸表**
**CMB 450-60(250 60) Installation Dimensions**

(本身底座) (With Pump Base)

级数	L	L <sub>1</sub>	L <sub>2</sub>	L <sub>3</sub>	L <sub>4</sub>	L <sub>5</sub>	L <sub>6</sub>	L <sub>7</sub>	L <sub>8</sub>	C	B	B <sub>1</sub>	B <sub>2</sub>	B <sub>3</sub>	H	H <sub>1</sub>	H <sub>2</sub>	h	h <sub>1</sub>	n-φd	4-φK
3	3281	725	390	1243	170	537	574	591	11.5	7	1000	850	710	500	560	550	355	45	35	4-φ42	φ35
4	3844	860	541	1243	160	537	727	591	11.5	7	1000	850	710	500	560	550	400	45	38	4-φ42	φ35
5	4197	1070	694	1263	190	537	880	591	11.5	7	1120	850	800	500	560	550	450	45	38	4-φ42	φ35
6	4350	1230	847	1263	190	537	1033	591	11.5	7	1120	850	800	500	560	550	450	45	38	4-φ42	φ35
7	4503	1380	1000	1263	190	537	1186	591	11.5	7	1120	850	800	500	560	550	450	45	38	4-φ42	φ35
8	4656	1535	1153	1263	190	537	1339	591	11.5	7	1120	850	800	500	560	550	450	45	38	4-φ42	φ35
9	5179	1685	1306	1423	190	537	1492	591	11.5	7	1250	850	900	500	560	550	500	45	38	4-φ42	φ42
10	5331	1840	1459	1423	190	537	1645	591	11.5	7	1250	850	900	500	560	550	500	45	38	4-φ42	φ42

**CMB 550-50 外型安装尺寸表**
**CMB 550-50 Installation Dimensions**

(本身底座) (With Pump Base)

级数	L	L <sub>1</sub>	L <sub>2</sub>	L <sub>3</sub>	L <sub>4</sub>	L <sub>5</sub>	L <sub>6</sub>	L <sub>7</sub>	L <sub>8</sub>	C	B	B <sub>1</sub>	B <sub>2</sub>	B <sub>3</sub>	H	H <sub>1</sub>	H <sub>2</sub>	h	h <sub>1</sub>	n-φd	4-φK
2	3448	725	390	1146.5	170	537	421	591	11.5	7	900	850	630	500	560	550	355	45	40	4-φ42	φ28
3	3693	860	541	1166.5	160	537	574	591	11.5	7	1000	850	710	500	560	550	400	45	40	4-φ42	φ35
4	3846	1075	694	1166.5	190	537	727	591	11.5	7	1000	850	710	500	560	550	400	45	40	4-φ42	φ35
5	3999	1230	847	1166.5	190	537	880	591	11.5	7	1000	850	710	500	560	550	400	45	40	4-φ42	φ35
6	4352	1380	1000	1186.5	190	537	1033	591	11.5	7	1120	850	800	500	560	550	450	45	40	4-φ42	φ35
7	4505	1535	1153	1186.5	190	537	1186	591	11.5	7	1120	850	800	500	560	550	450	45	40	4-φ42	φ35
8	4658	1685	1306	1186.5	190	537	1339	591	11.5	7	1120	850	800	500	560	550	450	45	40	4-φ42	φ35
9	5181	1840	1459	1346.5	190	537	1492	591	11.5	7	1250	850	900	500	560	550	500	45	40	4-φ42	φ42

CMB 580-70 外型安装尺寸表

CMB 580-70 Installation Dimensions

(本身底座) (With Pump Base)

级数	L	L <sub>1</sub>	L <sub>2</sub>	L <sub>3</sub>	L <sub>4</sub>	L <sub>5</sub>	L <sub>6</sub>	L <sub>7</sub>	L <sub>8</sub>	C	B	B <sub>1</sub>	B <sub>2</sub>	B <sub>3</sub>	H	H <sub>1</sub>	H <sub>2</sub>	h	h <sub>1</sub>	n-φd	4-φK
3	3777	870	450	1345	210	600	647	670	90	7	1000	950	710	550	615	609	400	55	38	4-φ46	φ35
4	4128	1050	630	1365	210	600	823	670	80	7	1120	950	800	550	615	609	450	55	38	4-φ46	φ35
5	4304	1220	800	1365	210	600	999	670	90	7	1120	950	800	550	615	609	450	55	38	4-φ46	φ35
6	4665	1400	980	1525	210	600	1175	670	90	7	1250	950	900	550	615	609	500	55	38	4-φ46	φ42
7	4841	1580	1160	1525	210	600	1351	670	80	7	1250	950	900	550	615	609	500	55	38	4-φ46	φ42
8	5017	1750	1330	1525	210	600	1527	670	90	7	1250	950	900	550	615	609	500	55	38	4-φ46	φ42
9	5823	1930	1550	1550	210	600	1703	670	80	7	1400	950	1000	550	615	609	560	55	45	4-φ46	φ42
10	5999	2100	1680	1550	210	600	1879	670	90	7	1400	950	1000	550	615	609	560	55	45	4-φ46	φ42

CMB 600-60 外型安装尺寸表

CMB 600-60 Installation Dimensions

(本身底座) (With Pump Base)

级数	L	L <sub>1</sub>	L <sub>2</sub>	L <sub>3</sub>	L <sub>4</sub>	L <sub>5</sub>	L <sub>6</sub>	L <sub>7</sub>	L <sub>8</sub>	C	B	B <sub>1</sub>	B <sub>2</sub>	B <sub>3</sub>	H	H <sub>1</sub>	H <sub>2</sub>	h	h <sub>1</sub>	n-φd	4-φK
3	4230	780	500	1510	140	805	715	801	60	7	1000	820	710	600	640	550	400	30	30	4-φ35	φ35
4	4410	960	680	1510	140	805	895	801	60	7	1000	820	710	600	640	550	400	30	30	4-φ35	φ35
5	4840	1140	860	1530	140	805	1075	801	60	7	1120	820	800	600	640	550	450	30	30	4-φ35	φ35
6	5020	1320	1040	1530	140	805	1255	801	60	7	1120	820	800	600	640	550	450	30	30	4-φ35	φ35
7	5200	1500	1220	1530	140	805	1435	801	60	7	1120	820	800	600	640	550	450	30	30	4-φ35	φ35
8	5550	1680	1400	1690	140	805	1615	801	60	7	1250	820	800	600	640	550	500	30	30	4-φ35	φ35
9	5550	1860	1580	1690	140	805	1795	801	60	7	1250	820	800	600	640	550	500	30	30	4-φ35	φ35
10	5550	2040	1760	1690	140	805	1975	801	60	7	1250	820	800	600	640	550	500	30	30	4-φ35	φ35

CMB 720-60 外型安装尺寸表

CMB 720-60 Installation Dimensions

(本身底座) (With Pump Base)

级数	L	L <sub>1</sub>	L <sub>2</sub>	L <sub>3</sub>	L <sub>4</sub>	L <sub>5</sub>	L <sub>6</sub>	L <sub>7</sub>	L <sub>8</sub>	C	B	B <sub>1</sub>	B <sub>2</sub>	B <sub>3</sub>	H	H <sub>1</sub>	H <sub>2</sub>	h	h <sub>1</sub>	n-φd	4-φK
2	3655	712	412	1226	150	618.5	518.5	607	39.5	7	1000	970	710	620	700	629	400	50	40	4-φ35	φ35
3	3840	897	597	1226	150	618.5	703.5	607	39.5	7	1000	970	710	620	700	629	400	50	40	4-φ35	φ35
4	4275	1082	782	1246	150	618.5	888.5	607	39.5	7	1120	970	800	620	700	629	450	50	40	4-φ35	φ35
5	4460	1267	967	1246	150	618.5	1073.5	607	39.5	7	1120	970	800	620	700	629	450	50	40	4-φ35	φ35
6	4915	1452	1152	1406	150	618.5	1258.5	607	39.5	7	1250	970	900	620	700	629	500	50	40	4-φ35	φ42
7	5100	1637	1337	1406	150	618.5	1443.5	607	39.5	7	1250	970	900	620	700	629	500	50	40	4-φ35	φ42
8	5285	1822	1522	1406	150	618.5	1628.5	607	39.5	7	1250	970	900	620	700	629	500	50	40	4-φ35	φ42

**CMB740-80 外型安装尺寸表**
**CMB740-80 Installation Dimensions**

(本身底座) (With Pump Base)

级数	L	L <sub>1</sub>	L <sub>2</sub>	L <sub>3</sub>	L <sub>4</sub>	L <sub>5</sub>	L <sub>6</sub>	L <sub>7</sub>	L <sub>8</sub>	C	B	B <sub>1</sub>	B <sub>2</sub>	B <sub>3</sub>	H	H <sub>1</sub>	H <sub>2</sub>	h	h <sub>1</sub>	n-φ d	4-φ K
2	3680	697	317	1363	190	465	599	638	111	7	1000	950	710	615	620	540	400	50	40	4-φ 42	φ 35
3	4069	875	495	1383	190	465	777	638	111	7	1120	950	800	615	620	540	450	50	40	4-φ 42	φ 35
4	4615	1053	673	1543	190	465	955	638	111	7	1250	950	900	615	620	540	500	50	40	4-φ 42	φ 42
5	4793	1231	851	1543	190	465	1133	638	111	7	1250	950	900	615	620	540	500	50	40	4-φ 42	φ 42
6	5321	1409	1029	1568	190	465	1311	638	111	7	1400	950	1000	615	620	540	560	50	40	4-φ 42	φ 42

**CMB12 外型安装尺寸表**
**CMB12 Installation Dimensions**

(公用底座) (With Common Base)

级数	L	L <sub>1</sub>	L <sub>2</sub>	L <sub>3</sub>	L <sub>4</sub>	L <sub>5</sub>	L <sub>6</sub>	L <sub>7</sub>	L <sub>8</sub>	C	B <sub>1</sub>	B <sub>2</sub>	B <sub>3</sub>	H	H <sub>1</sub>	H <sub>2</sub>	h	n-φ d
2	1153	1120	/	785	180	255	195	290	-40	3	410	410	170	260	210	112	35	4-φ 24
3	1298	1120	/	785	180	255	265	290	20	3	410	410	170	260	210	132	35	4-φ 24
4	1368	1120	/	785	180	255	335	290	80	3	410	410	170	260	210	132	35	4-φ 24
5	1574	1400	/	1060	165	255	405	293	-15	3	430	430	170	280	210	160	40	4-φ 24
6	1644	1400	/	1060	165	255	475	293	55	3	430	430	170	280	210	160	40	4-φ 24
7	1714	1580	/	1065	345	255	545	293	140	3	430	430	170	270	210	160	45	4-φ 24
8	1784	1580	/	1065	345	255	615	293	210	3	430	430	170	270	210	160	45	4-φ 24
9	1899	1580	/	1065	345	255	685	293	270	3	430	430	170	270	210	160	45	4-φ 24

**CMB16 外型安装尺寸表**
**CMB16 Installation Dimensions**

(公用底座) (With Common Base)

级数	L	L <sub>1</sub>	L <sub>2</sub>	L <sub>3</sub>	L <sub>4</sub>	L <sub>5</sub>	L <sub>6</sub>	L <sub>7</sub>	L <sub>8</sub>	C	B <sub>1</sub>	B <sub>2</sub>	B <sub>3</sub>	H	H <sub>1</sub>	H <sub>2</sub>	h	n-φ d
2	1260	1010	/	635	190	275	229	266	135	2	500	500	220	250	230	132	40	4-φ 26
3	1470	1260	/	850	190	275	306	266	35	2	480	480	220	285	230	160	40	4-φ 26
4	1589	1260	/	850	190	275	383	266	110	2	480	480	220	285	230	160	40	4-φ 26
5	1696	1415	/	1020	205	275	460	276	50	2	450	450	220	295	230	180	40	4-φ 23
6	1773	1415	/	1020	205	275	537	276	-45	2	450	450	220	325	230	180	40	4-φ 23
7	1967	1820	/	1000	410	275	614	288	225	2	545	545	220	300	230	200	40	4-φ 26
8	2046	1820	/	1000	410	275	691	288	275	2	545	545	220	300	230	200	40	4-φ 26
9	2123	1820	/	1000	410	275	768	288	315	2	545	545	220	300	230	200	40	4-φ 26

CMB 45 外型安装尺寸表

CMB 45 Installation Dimensions

(本身底座) (With Pump Base)

级数	L	L <sub>1</sub>	L <sub>2</sub>	L <sub>3</sub>	L <sub>4</sub>	L <sub>5</sub>	L <sub>6</sub>	L <sub>7</sub>	L <sub>8</sub>	C	B	B <sub>1</sub>	B <sub>2</sub>	B <sub>3</sub>	H	H <sub>1</sub>	H <sub>2</sub>	h	n-φd	4-φK
4	2014	600	330	707	135	304	351	340	3	4	368	520	460	250	345	250	280	40	4-φ24	φ24
5	2137	750	380	694	190	304	425	340	40	4	419	540	535	250	345	250	280	40	4-φ24	φ24
6	2408	750	380	785	190	304	499	340	53	4	406	540	535	250	345	250	315	40	4-φ24	φ28
7	2552	750	380	821	190	304	573	340	90	4	457	540	535	250	345	250	315	40	4-φ24	φ28
8	2626	900	525	779	190	304	647	340	61	4	457	520	510	250	345	250	315	40	4-φ24	φ28
9	2700	900	525	816	190	304	721	340	98	4	457	520	510	250	345	250	315	40	4-φ24	φ28

CMB25 外型安装尺寸表

CMB 25 Installation Dimensions

(公用底座) (With Common Base)

级数	L	L <sub>1</sub>	L <sub>2</sub>	L <sub>3</sub>	L <sub>4</sub>	L <sub>5</sub>	L <sub>6</sub>	L <sub>7</sub>	L <sub>8</sub>	C	B <sub>1</sub>	B <sub>2</sub>	B <sub>3</sub>	H	H <sub>1</sub>	H <sub>2</sub>	h	n-φd
2	1477	1180	/	740	21	245	262	287	125	2	520	520	280	335	300	180	40	4-φ24
3	1676	1480	/	1010	250	245	352	287	45	2	555	555	280	315	300	200	40	4-φ24
4	1766	1480	/	1010	250	245	442	287	135	2	555	555	280	315	300	200	40	4-φ24
5	1906	1560	530	1060	235	245	532	297	115	2	560	560	280	365	300	225	40	6-φ24
6	2111	1740	555	1115	360	245	622	297	275	2	530	600	280	350	300	250	40	6-φ24
7	2271	2210	700	1410	380	245	712	297	160	2	610	705	280	395	300	280	60	6-φ24
8	2361	2210	700	1410	380	245	802	297	215	2	610	705	280	395	300	280	60	6-φ24
9	2501	2210	700	1410	380	245	892	297	295	4	610	705	280	395	300	280	60	6-φ24

CMB25-80、CMB45-80、CMB85-80型  
次高压泵外形安装图

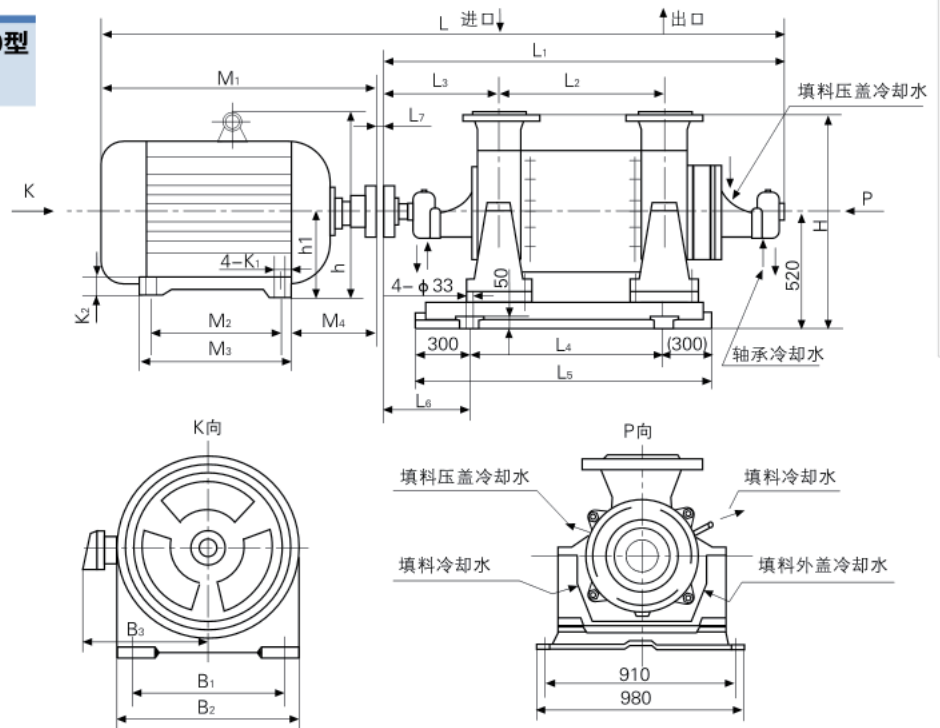

### CMB25-80型次高压泵外形安装尺寸表 CMB25-80 Installation Dimensions

(本身底座) (With Pump Base)

级数	L	L <sub>1</sub>	L <sub>2</sub>	L <sub>3</sub>	L <sub>4</sub>	L <sub>5</sub>	L <sub>6</sub>	L <sub>7</sub>	H	M1	M2	M3	M4	B <sub>1</sub>	B <sub>2</sub>	B <sub>3</sub>	h	h <sub>1</sub>	K1	K2
6	2480	1426	536	439	432	1032	532	4	870	1050	419	560	330	457	550	580	640	280	24	30
7	2559	1505	615	439	432	1032	532	4	870	1050	419	560	330	457	550	580	640	280	24	30
8	2828	1584	694	439	590	1190	532	4	870	1240	406	550	356	508	744	645	865	315	28	40
9	2977	1663	773	439	590	1190	532	4	870	1310	457	600	356	508	744	645	865	315	28	40
10	3056	1742	852	439	827	1427	532	4	870	1310	457	600	356	508	744	645	865	315	28	40
11	3135	1821	931	439	827	1427	532	4	870	1310	508	650	356	508	744	645	865	315	28	40
12	3214	1900	1010	439	827	1427	532	4	870	1310	508	650	356	508	744	645	865	315	28	40

### CMB45-80型次高压泵外形安装尺寸表 CMB45-80 Installation Dimensions

(本身底座) (With Pump Base)

级数	L	L <sub>1</sub>	L <sub>2</sub>	L <sub>3</sub>	L <sub>4</sub>	L <sub>5</sub>	L <sub>6</sub>	L <sub>7</sub>	H	M1	M2	M3	M4	B <sub>1</sub>	B <sub>2</sub>	B <sub>3</sub>	h	h <sub>1</sub>	K1	K2
6	2740	1426	536	439	432	1032	532	4	870	1310	508	650	356	508	744	645	865	315	28	40
7	2819	1505	615	439	432	1032	532	4	870	1310	508	650	356	508	744	645	865	315	28	40
8	2898	1584	694	439	590	1190	532	4	870	1310	508	650	356	508	744	645	865	315	28	40
9	3537	1663	773	439	590	1190	532	4	870	1870	900	1420	485	630	770	800	1170	355	28	40
10	3616	1742	852	439	827	1427	532	4	870	1870	900	1420	485	630	770	800	1170	355	28	40
11	3695	1821	931	439	827	1427	532	4	870	1870	900	1420	485	630	770	800	1170	355	28	40
12	3774	1900	1010	439	827	1427	532	4	870	1870	900	1420	485	630	770	800	1170	355	28	40

### CMB85-80型次高压泵外形安装尺寸表 CMB85-80 Installation Dimensions

(本身底座) (With Pump Base)

级数	L	L <sub>1</sub>	L <sub>2</sub>	L <sub>3</sub>	L <sub>4</sub>	L <sub>5</sub>	L <sub>6</sub>	L <sub>7</sub>	H	M1	M2	M3	M4	B <sub>1</sub>	B <sub>2</sub>	B <sub>3</sub>	h	h <sub>1</sub>	K1	K2
7	3575	1700	630	432	590	1032	643	5	880	1870	900	1510	485	630	770	800	1170	355	28	40
8	3655	1780	710	543	590	1190	643	5	880	1870	900	1510	485	630	770	800	1170	355	28	40
9	3735	1860	790	543	590	1190	643	5	880	1870	900	1510	485	630	770	800	1170	355	28	40
10	3815	1940	870	543	827	1427	643	5	880	1870	900	1510	485	630	770	800	1170	355	28	40
11	3895	2020	950	543	827	1427	643	5	880	1870	900	1510	485	630	770	800	1170	355	28	40
12	3975	2100	1030	543	827	1427	643	5	880	2090	1000	1510	545	710	810	850	1330	400	35	40

CMB 150-100型次高压泵外形安装图

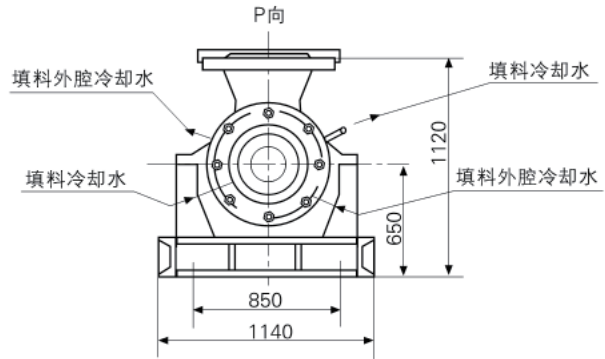
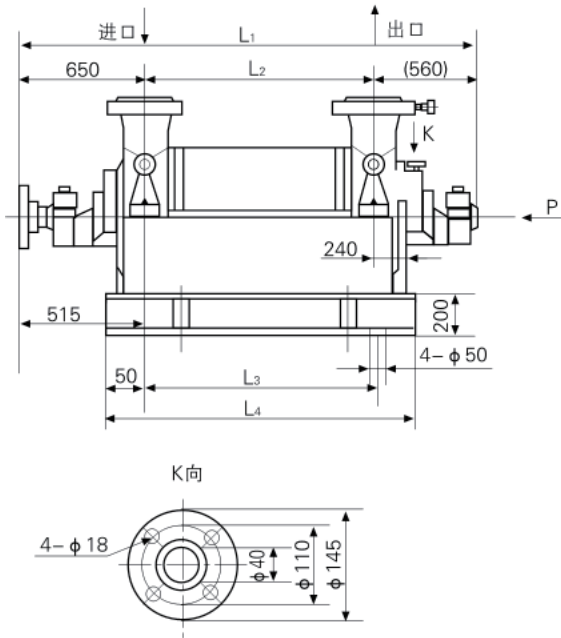

CMB 150-100次高压泵外形安装尺寸表  
CMB150-100 Installation Dimensions

(本身底座) (With Pump Base)

级数	L <sub>1</sub>	L <sub>2</sub>	L <sub>3</sub>	L <sub>4</sub>
6	2005	795	1085	1185
7	2110	900	1190	1290
8	2215	1005	1295	1395
9	2320	1110	1400	1500
10	2425	1215	1505	1605

次高压泵进、出口法兰尺寸 Flange Dimensions

泵型号 Type	进口法兰尺寸 Size of Inlet Flange								出口法兰尺寸 Size of Outlet Flange							
	Dg	D	D <sub>1</sub>	D <sub>2</sub>	D <sub>3</sub>	b	f <sub>1</sub> /f <sub>2</sub>	n-φd	Dg	D	D <sub>1</sub>	D <sub>2</sub>	D <sub>3</sub>	b	f <sub>1</sub> /f <sub>2</sub>	n-φd
CMB 25-80 CMB 45-80	80	195	160	135	/	22	-/3	8-18	65	220	170	138	109	32	4/3	8-25
CMB 85-80	100	220	180	155	/	22	-/3	8-18	100	265	210	172	149	38	4.5/3	8-30
CMB 150-100	200	360	310	278	/	30	-/4	12-22	150	350	290	250	203	43	4.5/3	12-34

## 进、出口法兰尺寸表 Flange Dimensions

泵型号 Type	进口法兰尺寸 Size of Inlet Flange								出口法兰尺寸 Size of Outlet Flange							
	Dg	D	D <sub>1</sub>	D <sub>2</sub>	D <sub>3</sub>	b	f <sub>1</sub> /f <sub>2</sub>	n-φd	Dg	D	D <sub>1</sub>	D <sub>2</sub>	D <sub>3</sub>	b	f <sub>1</sub> /f <sub>2</sub>	n-φd
CMB 6-25	40	130	100	80	/	16	-/3	4-13.5	40	150	110	88	75	20	4/3	4-17.5
CMB 6-50	50	160	110	90	/	30	-/3	4-13.5	50	175	135	105	87	28	4/3	4-23
CMB 12-25	50	140	110	90	/	16	-/3	4-13.5	40	150	110	88	75	20	4/3	4-17.5
CMB 12-50	50	160	110	90	/	30	-/3	4-13.5	50	175	135	105	87	28	4/3	4-23
CMB 25-30	65	160	130	110	/	16	-/3	4-13.5	65	185	145	122	109	24	4/3	8-17.5
CMB 25-50	80	190	150	128	/	18	-/3	4-17.5	80	215	170	133	120	30	4/3	8-22
CMB 25-50	80	215	170	133	120	30	4/3	8-22	80	215	170	133	120	30	4/3	8-22
CMB 46-30	80	190	150	128	/	18	-/3	4-17.5	65	185	145	122	109	24	4/3	8-17.5
CMB 46-50	80	190	150	128	/	18	-/3	4-17.5	80	215	170	133	120	30	4/3	8-22
CMB 46-50	80	215	170	133	120	30	4/3	8-22	80	215	170	133	120	30	4/3	8-22
CMB 85-45	100	210	170	148	/	18	-/3	4-17.5	100	235	190	158	149	28	4.5/3	8-22
CMB 85-67	150	265	225	202	/	20	-/3	8-17.5	150	345	280	212	203	33	4.5/3	8-33
CMB 85-67	150	345	280	212	230	33	4.5/3	8-33	150	345	280	212	203	33	4.5/3	8-33
CMB 120-50	125	240	200	178	/	20	-/3	8-17.5	125	270	220	184	175	30	4.5/3	8-26
CMB 155-67	150	265	225	202	/	20	-/3	8-17.5	150	345	280	212	203	33	4.5/3	8-33
CMB 155-67	150	345	280	212	203	33	4.5/3	8-33	150	345	280	212	203	33	4.5/3	8-33
CMB 280-43 (200 43)	200	340	295	268	/	28	-/3	8-22	200	375	320	285	259	38	4.5/3	12-30

进、出口法兰尺寸表 Flange Dimensions

泵型号 Type	进口法兰尺寸 Size of Inlet Flange								出口法兰尺寸 Size of Outlet Flange							
	Dg	D	D <sub>1</sub>	D <sub>2</sub>	D <sub>3</sub>	b	f <sub>1</sub> /f <sub>2</sub>	n-φd	Dg	D	D <sub>1</sub>	D <sub>2</sub>	D <sub>3</sub>	b	f <sub>1</sub> /f <sub>2</sub>	n-φd
CMB 280-65 (200 65)	200	340	295	268	/	30	-/3	12-22	200	415	345	285	259	44	4.5/3	12-36
CMB 360-40	200	340	295	268	/	28	-/3	8-22	200	375	320	285	259	38	4.5/3	12-30
CMB 450-60 (250 60)	250	405	355	320	/	32	-/3	12-26	250	470	400	345	312	48	4.5/3	12-36
CMB 550-50	250	405	355	320	/	32	-/3	12-26	250	470	400	345	312	48	4.5/3	12-36
CMB 580-70	300	465	410	370	/	32	-/3	12-26	300	560	489	/	381	67	7/-	20-36
CMB 600-60	300	465	410	370	/	32	-/3	12-26	250	470	400	345	312	48	4.5/3	12-36
CMB 720-60	300	460	410	370	/	34	-/4	12-24	300	530	460	412	363	54	4.5/4	12-39
CMB 740-80	300	530	460	412	/	32	-/3	16-41	300	585	500	442	/	48	4.5/3	16-48
80CMB12	80	190	150	128	/	18	-/3	4-17.5	80	200	160	133	/	26	-/3	8-17.5
CMB 80-30	80	195	160	135	/	22	-/3	4-17.5	80	200	160	133	/	26	-/3	8-17.5
100CMB16	100	210	170	148	/	18	-/3	4-17.5	100	220	180	158	/	24	-/3	8-17.5
100CMB45	100	210	170	148	/	18	-/3	4-17.5	100	235	190	158	149	28	4.5/3	8-22
125CMB25	125	240	200	178	/	20	-/3	8-17.5	125	270	220	184	175	30	4.5/3	8-26
150CMB30	150	285	240	212	/	26	-/3	8-22	150	300	250	212	203	34	4.5/3	8-26

## 可能发生故障及其解决方法

常见故障	原因	解决方法
水泵不出水	1、启动前注入泵内的水不够(当使用真空泵时,则抽真空不够) 2、转向不对 3、底阀未打开或被堵塞 4、泵的吸水高度过高 5、进水管或仪表联接处漏气 6、填料函部位漏气 7、叶轮流道被堵塞 8、泵转速不够	1、注水至少淹没叶轮,最好充满泵腔(抽真空时同)。 2、更换电机接线。 3、检查底阀,清洗检修或更新。 4、降低泵的安装高度。 5、拧紧或堵塞漏气处。 6、检查轴套及轴套螺母,漏气时应及时加垫 7、清洗叶轮。 8、检查电机,检修或更新,
流量不足或不出水	1、水流通道被堵塞 2、叶轮和密封环之间的间隙泄漏太大 3、转速未达到规定值	1、依次检查进出水流道是否畅通,排除堵塞物。 2、检修或更换叶轮和密封环。 3、检查电压是否过低,检查电机是否损坏,检修电机和调整电压。
水泵消耗功率过大,电机电流超过额定值	1、填料压得过紧 2、泵的转子与定子摩擦 3、流量超过了使用范围 4、平衡盘与平衡环摩擦 5、水泵内间隙过大,泵效率降低	1、调松填料 2、检查转子与定子摩擦部位 3、在规定的流量范围内使用水泵 4、检查平衡盘的端面跳动,磨损太大应更换 5、解体检查,更换已磨损件
水泵响声异常和振动	1、发生了汽蚀 2、机件松动或脱落 3、转子不平衡 4、轴弯曲 5、泵轴与电机轴不同心 6、基础薄弱 7、轴承磨损 8、水泵内间隙过大	1、降低水泵安装高度,简化进水管路,减少管路损失 2、停车检查,紧固零件 3、转子作平衡试验,车削不平衡重量 4、调直主轴 5、调整机组,使之同心 6、加固基础 7、更换轴承 8、解体检查,更换已磨损件
轴承过热	1、润滑不良 2、轴弯曲 3、轴承损坏 4、泵轴与电机轴不同心 5、冷却水不足或断水	1、加油(检查油环,使之旋转) 2、调直主轴 3、更换轴承 4、调整机组,使之同心 5、检查冷却水情况

## The possibility of failure and the solution

Common faults	Reason	The solution
Water pump is not out of the water	1、Startup injection pump enough water (using a vacuum pump, it is vacuum is not enough) 2、Turn to right 3、Bottom valve does not open or blocked 4、Pump suction height is too high 5、Inlet pipe or leak at the instrument connection 6、Stuffing box parts air leakage 7、Impeller passage was blocked 8、Pump speed is not enough	1、Water injection at least submerged impeller, the best full of pump cavity (the same time when the vacuum) 2、Replace the motor wiring 3、Check the bottom valve, cleaning maintenance or updates 4、Reduce the installation height of pump 5、Tighten or blocked air leakage 6、Check the shaft sleeve and the sleeve nut, flat linen padded 7、Clean the impeller 8、Check the motor, maintenance or updates
Insufficient flow or no flow ( capacity not enough or Not out of the water )	1、The water channels blocked 2、Clearance between impeller and seal ring reveal too much 3、Speed did not reach the specified value	1、In turn, check in and out of the water was clear, eliminate blockages 2、Check or replace impeller and sealing ring 3、Check whether the voltage is too low, check whether the motor is bad, motor and adjust the voltage
Water pump power consumption is too large, motor traffic more than ratings	1、Too tightly on the packing 2、Pump rotor and stator rubbing 3、Traffic over the scope of use 4、The balance disc and balance ring friction 5、Inside the pump clearance is too large, the pump efficiency is lower	1、The loose packing 2、Check rotor and stator friction parts 3、The prescribed flow range using pumps 4、Check the balance disc face runout, wear too big should be replaced 5、Strip inspection and replacement has wear parts
The pump abnormal noise and vibration	1、The cavitation 2、Parts loose or fall off 3、The rotor imbalance 4、Shaft bending 5、Pump shaft and motor shaft is different 6、Weak basis 7、Bearing wear 8、Inside the pump clearance is too large	1、Water reduce water pump installation height, simplify, reduce line losses 2、Stop inspection, fastening parts 3、The rotor dynamic balance test, turning don't balance weight 4、Straightening the main pump 5、Adjust the spindle, concentric 6、Reinforce the foundation 7、Replace the bearing 8、Strip inspection and replacement has wear parts
Bearing overheating	1、Bad lubrication 2、Shaft bending 3、Bearing damage 4、Pump shaft and motor shaft is different 5、Insufficient cooling water or without water	1、refuel ( check the oil ring, rotating) 2、Straightening the spindle 3、Replace the bearing 4、Adjusting unit, and make it work 5、Check the cooling water